

Godišnjak 2015. - 2016. Drvnotehnološkog odsjeka

Edited book / Urednička knjiga

Publication status / Verzija rada: **Published version / Objavljena verzija rada (izdavačev PDF)**

Publication year / Godina izdavanja: **2017**

Permanent link / Trajna poveznica: <https://urn.nsk.hr/urn:nbn:hr:108:232674>

Download date / Datum preuzimanja: **2025-01-24**



Repository / Repozitorij:

[University of Zagreb Faculty of Forestry and Wood Technology](#)



GODIŠNJAK

2015. — 2016.

YEARBOOK

Drvnotehnološkoga odsjeka
Wood Technology Section



Izdavač: Sveučilište u Zagrebu, Šumarski fakultet
Za izdavača: Prof. dr. sc. Vladimir Jambreković
Urednica: Izv. prof. dr. sc. Silvana Prekrat
Grafičko oblikovanje i priprema za tisak:
Ana Hruškar Varović, Denona d. o. o. Zagreb
Prijevod i lektura: SPESS d.o.o.
Tisak: Denona d. o. o. Zagreb
Naklada: 500 kom
Mjesto i datum: Zagreb, 2017.
ISBN: 978-953-292-054-3

Publisher: University of Zagreb, Faculty of Forestry
For the publisher: Vladimir Jambreković, PhD, Professor
Editor: Silvana Prekrat, PhD, Associate Professor
Graphic design and preparation:
Ana Hruškar Varović, Denona d. o. o. Zagreb
Translation and proofreading: SPESS
Printing: Denona d. o. o. Zagreb
Circulation: 500 copies
Place and date: Zagreb, 2017
ISBN: 978-953-292-054-3

Sadržaj / Contents

PREDGOVOR FOREWORD	6
UVODNA RIJEČ DEKANA DEAN'S INTRODUCTORY WORD	8
STUDIJI DRVNOTEHNOLOŠKOGA ODSJEKA STUDY PROGRAMMES IN THE WOOD TECHNOLOGY SECTION	11
ZAVRŠNI RADOVI I PROMOCIJA PRVOSTUPNIKA BACHELOR'S THESES AND BACHELOR GRADUATION CEREMONY	
Haris Bešić	22
Zrinka Bridić	24
Ivan Lacković	26
Tomislav Pipić	28
Denis Svitlanović	30
Filip Veseličić	32
DIPLOMSKI RADOVI I PROMOCIJA MAGISTARA INŽENJERA MASTER'S THESES AND MASTER GRADUATION CEREMONY	
Oblikovanje proizvoda od drva Wood product design	
Andrea Begović	40
Lucija Brglez	42
Danijela Gadže	44
Martino Grgić	46
Karla Harazim	48
Lana Jarža	50
Margareta Kovačević	52
Ana Mišetić	54
Drvnotehnološki procesi Wood technology processes	
Juraj Ančić	60
Josip Bakija	62
Krešimir Balaško	64
Ivica Kupinić	68
Ivan Matušin	70
Marija Novosel	72
Josip Ožegović	74
Ivan Ravnjak	76
REKTOROVA NAGRADA RECTOR'S AWARD	
Lana Jarža	80
Juraj Stanešić	82
SEMINARSKI RADOVI SEMINAR PAPERS	
Lovro Belina	86
Lucija Brglez	88
Franciska Klanfar	90
Igor Kolman	92
Magareta Kovačević	94
Ana Mišetić	96
Lovro Belina, Ivana Hideg, Franciska Klanfar, Igor Kolman, Domagoj Mamić, Tomica Perković, Ivan Ražov, Valentino Slivar, Juraj Tomljanović	98

MEĐUPREDMETNI PROJEKTI

INTERDISCIPLINARY PROJECTS

Kako zavoljeti Konstrukcije proizvoda od drva? – Kućice za ptice How to get to love Constructions of Wooden Products? – Bird houses	102
--	-----

IZVANNASTAVNA AKTIVNOST

EXTRACURRICULAR ACTIVITIES

Projektiranje učionice za e-učenje Designing of an e-learning classroom	108
--	-----

IZVANFAKULTETSKA SURADNJA

OUT OF FACULTY COOPERATION

Suradnja s udrugom HRAST Cooperation with the HRAST Association	114
Suradnja s tvrtkom Bokart Cooperation with the company Bokart	116
Međunarodni projekt Creapolis International project Creapolis	130

IZLOŽBE I KONFERENCIJE

EXHIBITIONS AND CONFERENCES

Tjedan dizajna Design week	134
Ambienta	136
Mjesec oblikovanja Design month	138
A.L.I.C.E.	140

TERENSKA NASTAVA

FIELD CLASSES

Terenska nastava u Hrvatskoj Field classes in Croatia	144
Inozemna terenska nastava Field classes abroad	146

MOBILNOST

MOBILITY

.....	149
-------	-----

NAŠI BUDUĆI STUDENTI

OUR FUTURE STUDENTS

.....	154
-------	-----

I ONI SU BILI STUDENTI DRVNOTEHNOLOŠKOGA ODSJEKA

AND ONCE THEY HAVE BEEN STUDENTS OF THE WOOD TECHNOLOGY DEPARTMENT

Vinko Postić	158
Pero Martinić-Jerčić	162

PREĐGOVOR

Godišnjak nastavne aktivnosti preddiplomskoga i diplomskih studija Drvnotehnološkoga odsjeka nastao je prvi put ove godine. Zamisao izrade godišnjaka jedno je od rješenja smanjenja broja problema u radu navedenih u publikaciji Samoanaliza Šumarskoga fakulteta. SWOT analizom provedenom radi strategije razvoja Šumarskoga fakulteta za razdoblje 2011. – 2016. nedostupnost informacija u javnosti istaknuta je kao jedna od slabosti sustava. Osim navedenoga, godišnjak daje odgovore i na još neke tada navedene slabosti kao što je veća razina suradnje sa studentima, motiviranost ili suradnja s drvnom strukom. Poticaj sakupljanja materijala i inspiracija izrade godišnjaka u obliku kako je predstavljen, crpljen je iz dugogodišnjega osobnoga znanstvenog, nastavnog i stručnog rada, no velikim dijelom zaslugom dekana prof. dr. sc. Vladimira Jambrekovića, koji je iskazao potporu ideji, a i sam bio urednik slične publikacije pod naslovom Sveučilište u Zagrebu Šumarski fakultet u akad. god. 2014./2015.

Uz dekana svakako dugujem zahvalu svim nastavnicima i studentima koji su predano radili i pozdravili ideju tiskanja ovakve publikacije te svojim priložima doprinijeli sadržaju godišnjaka.

Sadržaj godišnjaka obuhvaća pregled aktivnosti koje su ostvarili studenti zajedno s nastavnicima i suradnicima unutar ili izvan kolegija na preddiplomskome studiju Drvne tehnologije i diplomskim studijima Drvnotehnološki procesi i Oblikovanje proizvoda od drva Drvnotehnološkoga odsjeka tijekom akademske godine 2015./2016. Raspon sadržaja i broja aktivnosti na spomenuta tri studija dovoljna su za predstavljanje djelokruga rada, što ne umanjuje važnost ostvarenih rezultata na ostalim stupnjevima, specijalističkim i doktorskom studiju.

Popularizacija korištenja drva, njegova obnovljivost kao i ekonomski pokazatelji drvnoindustrijskoga sektora govore u prilog svakodnevnome razvoju drvne struke i potrebe za visokoobrazovanim stručnjacima u području obrade i prerade drva. Kao i svaka struka tako i ta svakodnevno razvija nove materijale i tehnološke postupke obrade i prerade drva, za što su potrebna stručna znanja temeljena na znanstvenim istraživanjima. Naša institucija ima dugu tradiciju u obrazovanju visokoobrazovanih kadrova koji djeluju najčešće u primarnoj ili finalnoj drvoprerađivačkoj struci. Oblikovanje proizvoda od drva kao zaseban smjer diplomskoga studija logičan je slijed razvoja Drvnotehnološkoga odsjeka, kojim zajedno sa Šumarskim odsjekom zatvaramo ciklus od uzgoja šuma do gotovoga proizvoda i njegova zbrinjavanja nakon uporabe s utjecajem na okoliš.

Zbog toga smo spremni surađivati i pomoći ostalim strukama koje su možda prepoznatljivije u području oblikovanja namještaja, proizvoda od drva i opremanja drvom i drvnim proizvodima.

Nadam se da će i ovaj godišnjak pridonijeti boljoj prepoznatljivosti Drvnotehnološkoga odsjeka i da će privući znatizeljnike bilo kao promatrače bilo kao buduće stručnjake.

Urednica godišnjaka
Voditeljica diplomskoga studija Oblikovanje proizvoda od drva
Izv. prof. dr. sc. Silvana Prekrat

FOREWORD

This is the first year that we have compiled the Yearbook of teaching activities in the undergraduate and graduate studies of the Wood Technology Section. The idea to compile a yearbook was one of the ways to resolve a number of issues listed in the publication *Self-assessment of the Faculty of Forestry*. The SWOT analysis conducted as part of the development strategy for the Faculty of Forestry for the period 2011–2016 pointed at the lack of public access to information as one of the weaknesses in the system. Additionally, the yearbook provides answers to other listed weaknesses, such as the need for a greater level of cooperation with students, motivation or co-operation with the wood profession. The motivation to collect the materials and the inspiration for shaping the yearbook in this form came from many years of personal scientific, teaching and professional work, but also largely thanks to the Dean Vladimir Jambreković, PhD Professor who expressed his support for the idea, and was also the editor of a similar publication for the University of Zagreb, Faculty of Forestry for the 2014/2015 academic year.

I would also like to thank all the lecturers and students who have worked so hard and supported the idea of printing such a publication, and given their contributions to the content of the yearbook.

The yearbook provides an overview of the activities achieved by students together with lecturers and associates, within or outside the courses in the undergraduate study of Wood Technology, and graduate studies Wood Technology Processes and Wood Product Design in the Wood Technology Section during the 2015/2016 academic year. The range of content and the number of activities in these three study programmes is sufficient to illustrate the scope of work within the Section, without reducing the importance of the results achieved at other levels, particularly the specialist and doctoral study programmes.

Popularisation of the use of wood, its sustainability as well as economic indicators of the wood industry sector support the need for constant development of professions based on wood and for highly educated experts in wood processing. Like any other profession, new materials and technologies are developed daily in wood processing, which demands expert knowledge based on scientific research. Our institution has a long tradition in the education of highly trained experts, who primarily work in primary or final wood processing. Wood Product Design as a separate specialisation in the undergraduate programme is the logical next step in the development of the Wood Technology Section. Together with the Forestry Section, we are closing the cycle, from cultivating forests to finished wood products, and their management after their use with impacts on the environment.

For that reason, we are willing to cooperate and assist other professions that may be more recognisable in the field of production of furniture and wood products.

I sincerely hope that this yearbook will contribute to better recognisability of the Wood Technology Sector, and that it will attract the attention of many, from amateurs to future experts.

Yearbook Editor
Head of the graduate study programme Wood Product Design
Silvana Prekrat, PhD, Associate Professor

UVODNA RIJEČ DEKANA

Korijeni Šumarskoga fakulteta datiraju iz 1898. godine kada je osnovana Šumarska akademija u sklopu Filozofskoga fakulteta. Nakon Drugoga svjetskog rata potreba za stručnjacima u području drvne industrije 1947. godine rezultira podjelom nastave na dva smjera: šumsko-uzgojni i šumsko industrijski ili biološki i tehnički. Prvi je smjer obrazovao stručnjake za uzgoj šuma i upravu, a drugi za tehničke radove u šumarstvu i drvnoj industriji. Uz javnosti prepoznatljiviji Šumarski odsjek i naš manje poznati Drvnotehnoški odsjek djeluje unutar Šumarskoga fakulteta. Skori sedamdeseti rođendan govori u prilog da je krajnje vrijeme da djelokrug i uspjehe našega rada bolje predstavimo i podijelimo s javnošću. Brojne su se organizacijske promjene događale, no najveća je uslijedila reformom visokoškolskoga obrazovanja u skladu s načelima Bolonjske deklaracije iz 1999. godine. Akademске godine 2001./2002. nastavni su planovi sadržavali elemente reforme strukture sustava visokoga obrazovanja. U nove nastavne planove uvedeni su moduli, a nastava se prilagođavala dinamičnim znanstvenoga i tehnološkoga napretka. Prvi je put u nastavne planove i programe uvedeno bodovanje po ECTS-u (*European Credit Transfer System*), odnosno europskomu sustavu prijenosa bodova.

Svakodnevno ostvarujemo našu viziju sustavnoga razvoja nacionalno i međunarodno prepoznate izvrsnosti u obrazovanju i istraživanju u šumarstvu, drvnoj tehnologiji i srodnim područjima koja se temelji na uspostavi sustava kvalitete te prijenosu i primjeni znanja za dobrobit i prosperitet svih sastavnica društvene zajednice. Stvaranjem i primjenom novih znanstvenih spoznaja osiguravamo trajni razvoj kako bi polaznicima obrazovnih programa pružali znanje u skladu s potrebama društva.

Naša misija kao najstarije i vodeće nacionalne ustanove u svojem djelokrugu je u stvaranju i širenju znanja utemeljenoga na suvremenim znanstvenim spoznajama. Prioritet su djelovanja studenti za koje su razvijeni obrazovni programi, što će ih učiniti vrsnim stručnjacima i vrlim pojedincima na dobrobit našega društva. Postavljene ciljeve ostvarujemo svjesno i mjerljivo, kroz razvoj sustava osiguravanja kvalitete u svim područjima aktivnosti Fakulteta.

Drvena je tehnologija znanost i struka, a definira se kao integrirana primjena prirodnih i tehničkih znanosti u svrhu proizvodnje proizvoda od obnovljivoga prirodnog resursa – drva. Specifičnost je toga znanstvenog polja i struke u tome što se bavi razvojem i oblikovanjem novih proizvoda na osnovi drva i drvnih materijala, te specifičnim procesnim i proizvodnim tehnologijama njihove prerade i obrade primjerene zahtjevima biomaterijala. Usto, područje drvne tehnologije sve je važnije i zbog primjene biomase kao ekoen-ergenta. Šumarstvo, prerada drva i proizvodnja namještaja nude ekonomske, razvojne i socijalne prednosti i mogućnosti. Važan su izvor zapošljavanja i ekonomskoga prosperiteta u nas i u svijetu, ali uz oprezno balansiranje s multifunkcijskom ulogom šume. Održivost i višefunkcionalnost šuma moraju biti usmjerene k funkciji održivoga razvoja i ekološki učinkovite industrije bazirane na preradi drva. Pri donošenju odluke za upis na naš Fakultet dobro ocijenite vaša očekivanja i mogućnosti struka za koje obrazujemo jer donosite najvažniju životnu odluku.

Dekan Šumarskoga fakulteta
Prof. dr. sc. Vladimir Jambreković

DEAN'S INTRODUCTORY WORD

The roots of the Faculty of Forestry date back to 1898, when the Forestry Academic was established as part of the Faculty of Philosophy. After World War II, the need for experts in the wood industry resulted into a splitting of classes into two sections in 1947: forestry and silviculture, and the forestry industry or biological and technical. The first section trained experts in cultivating and managing forests, while the second was focused on technical works in forestry and the wood industry. The well-known Forestry Section, and our lesser known Wood Technology Sector, today operate within the Faculty of Forestry. Our upcoming 70th anniversary has made it clear that the time has come to better present our work and our successes to the general public. During our history, we have gone through numerous organisational changes, the most significant following the higher education reforms based on the principles of the 1999 Bologna Declaration. In the 2001/2002 academic year, teaching plans included elements of the reforms to the higher education system. Modules were introduced into the new teaching plans, and classes adapted to the dynamics of scientific and technological advancements. For the first time, teaching plans and programmes were credit points were introduced in line with the *European Credit Transfer System* (ECTS).

We are achieving our vision of the systematic development of nationally and internationally recognisable excellence in education and research in forestry, wood technology and related fields which is based on the establishment of a quality system, and the transfer and application of knowledge for the benefit and prosperity of all components of our society. Through the creation and application of new scientific knowledge, we ensure a lasting development, to ensure that we are providing our students with the knowledge aligned with the needs of our society.

Our mission, as the oldest and leading national institution in its field, is to develop and disseminate knowledge based on contemporary scientific findings. Our priority is our students, for whom these educational programmes have been developed, in order to help them develop into skilled professionals and upstanding individuals to the benefit of our society. We achieve our goals conscientiously and diligently to achieve our goals through development of the quality assurance system in all areas of activities at the faculty.

Wood technology is a science and a profession, and is defined as the integrated application of the natural and technical sciences, for the purpose of producing products from renewable resources – wood. The specificity of this scientific field and profession is that it deals with the development and shaping of new products based on wood and wood materials, and the specific process and production technologies for their processing and the specific requirements of biomaterials. Additionally, wood technology is even more important due to the use of biomass as a renewable energy source. Forestry, wood processing and furniture production offer economic, developmental and societal advantages and opportunities. They are an important source of employment and economic prosperity in Croatia and in the world, and require the careful balancing of the multifunctional role of the forest. Sustainable and multifunctional forests must be directed towards the functions of sustainable development and ecologically efficient industries based on wood processing. In deciding on whether to enrol into our faculty, a potential student should carefully assess their expectations and the opportunities of the available in this profession, as this is one of the life's most important decisions.

Dean, Faculty of Forestry
Professor Vladimir Jambreković, PhD

Studiji Drvnotehnološkoga odsjeka

–

Study programmes in the Wood
Technology Section

Studiji Drvnotehnološkoga odsjeka

Study programmes in the Wood Technology Section

Na Drvnotehnološkome odsjeku Šumarskoga fakulteta obrazovanje studenata moguće je na nekoliko razina: preddiplomskome stručnom studiju, preddiplomskome sveučilišnom studiju, diplomskome, specijalističkome i doktorskome.

Od 2005. nastava na Šumarskome fakultetu odvija se po modelu 3 + 2 godine. Danas na Drvnotehnološkome odsjeku uz jedan stručni preddiplomski studij Drvna tehnologija djeluje jedan preddiplomski studij Drvna tehnologija, dva diplomatska studija Drvnotehnološki procesi i Oblikovanje proizvoda od drva, dva specijalistička studija Organizacija proizvodnje i Tehnologija drvnih materijala. Stjecanje naslova doktora biotehničkih znanosti ostvarivo je upisom na doktorski studij pod nazivom Šumarstvo i drvna tehnologija.

Preddiplomski sveučilišni studij traje šest semestara (tri godine, 180 ECTS). Nakon završena studija stječe se naziv prvostupnik/prvostupnica drvne tehnologije.

Daljnji stupanj školovanja moguće je ostvariti na diplomatskim studijima Drvnotehnološki procesi ili Oblikovanje proizvoda od drva. Diplomski studiji traju četiri semestra (dvije godine, 120 ECTS). Završetkom diplomatskoga studija i obranom diplomatskoga rada studentu se uručuje diploma kojom se potvrđuje završetak studija i stjecanje akademskoga naziva magistar/magistrice drvne tehnologije – drvnotehnološki procesi ili magistar/magistrice drvne tehnologije – oblikovanje proizvoda od drva.

Nakon završena diplomatskog studija moguće je upisati specijalistički ili doktorski studij.

At the Wood Technology Section of the Faculty of Forestry, student education is offered at several levels: undergraduate professional, undergraduate university, graduate, specialist and doctoral.

Since 2005, the programmes at the Faculty of Forestry are structured as 3 + 2 years. Today, beside an undergraduate professional programme – Wood Technology – being offered, there is also an undergraduate university programme – Wood Technology. The two graduate programmes offered are Wood Technology Processes and Wood Product Design, while the two specialist programmes are Production Organisation and Technology of Wood Materials. Completing the doctoral programme in biotechnical sciences entitled Forestry and Wood Technology, grants the title of Doctor of Biotechnical Science.

The undergraduate university programme has a duration of six semesters (three years, 180 ECTS). Upon completion of the programme, the title of bacchalaureus of wood technology is granted.

The next educational level is the graduate level, with two study programmes offered: Wood Technology Processes and Wood Product Design. The graduate programme lasts four semesters (two years, 120 ECTS). Upon completion of the graduate programme and defence of the Master's thesis, the student is granted the title of a Master of Wood Technology in wood technology processes, or Master of Wood Technology in wood product design. With the completed Master's degree, the student may enrol into a specialist or doctoral programme.

Preddiplomski studij Drvena tehnologija

Undergraduate Study Programme Wood Technology

Broj ECTS	1	2	3	4	5	6	7	8	9	10	11	12	13	14	15	16	17	18	19	20	21	22	23	24	25	26	27	28	29	30
Semestar																														
1.	Matematika / Mathematics 45+45 7 ECTS				Fizika / Physics 30+30 5 ECTS				Kemija drva / Wood Chemistry 45+45 8 ECTS				Anatomija drva / Wood Anatomy 45+60 10 ECTS										Tjelesna i zdravstvena kultura / Physical Education		Strani jezik / Foreign language – English or German 0+30					
2.	Tehnička mehanika / Engineering Mechanics 30+30 5 ECTS		Osnove dendrologije / The Basics of Dendrology 15+30 3 ECTS		Primjenjena tehnička grafika / Applied Technical Graphics 15+30 5 ECTS			Drvnoindustrijsko strojarstvo / Woodindustry Engineering 30+30 5 ECTS			Osnove elektrotehnike / Basics of Electrotechnics 30+30 4 ECTS			Tehnička svojstva drva 1 / Technical Properties of Wood 1 45+60 8 ECTS										Tjelesna i zdravstvena kultura / Physical Education		Strani jezik / Foreign language – English or German 0+30				
3.	Strojevi za obradu drva / Woodworking Machinery 45+45 6 ECTS				Tehnička svojstva drva II / Technical Properties of Wood 2 30+30 4 ECTS				Zaštita drva / Wood Protection 45+45 7 ECTS				Osnove statistike / Basic Statistics 30+30 4 ECTS			Transportna tehnika u DI / Transport Equipment in Wood Industry 30+45 5 ECTS			Terenska nastava / Fieldwork 5 dana 4 ECTS		Tjelesna i zdravstvena kultura / Physical Education									
4.	Konstrukcije proizvoda od drva I / Constructions of Wooden Products 1 45+45 7 ECTS				Sušenje drva i drvnih materijala / Drying of Wood and Wood Materials 30+45 5 ECTS				Pilarska tehnologija drva I / Sawmilling Technology 1 30+45 5 ECTS			Ljepila i lijepljenje drva / Glues and Wood Gluing 30+30 4 ECTS			Ploče od usitnjenog drva / Fragmented Wood Panels 30+45 5 ECTS			Terenska nastava / Fieldwork 5 dana 4 ECTS		Tjelesna i zdravstvena kultura / Physical Education										
5.	Furniri i furnirske ploče / Veneer and Veneer Plywood 30+45 5 ECTS		Organizacija proizvodnje / Production Organisation 45+45 7 ECTS				Tehnologija finalne obrade drva / Final Wood Processing 45+45 6 ECTS			Drvo u graditeljstvu / Wood as a Building Material 30+30 4 ECTS			Trgovina drvom i drvnim proizvodima / Marketing of Wood Products 30+30 4 ECTS			Terenska nastava / Fieldwork 5 dana 4 ECTS														
6.	Planiranje i obracun proizvodnje / Production Planning and Calculation 30+45 5 ECTS		Površinska obrada drva / Wood Finishing 30+45 5 ECTS		Izborna skupina A Vođenje proizvodnih procesa I / Operations Management 1 30+30 3 ECTS			Tehnološke karakteristike drva / Technological Properties of Wood 30+30 3 ECTS		Strojevi za obradu drva II / Woodworking Machinery 30+30 3 ECTS		Završni rad / Bachelor Thesis 0+45 7 ECTS										Terenska nastava / Fieldwork 5 dana 4 ECTS								
				Izborna skupina B Konstrukcije proizvoda od drva II / Constructions of Wooden Products 2 30+30 3 ECTS			Ojastučeni namještaj / Upholstered Furniture 30+30 3 ECTS		Oblikovanje namještaja / Furniture Design 30+30 3 ECTS																					

	Izborna skupina A / Election group A
	Izborna skupina B / Election group B
	Tjelesna i zdravstvena kultura / Physical Education.
	Strani jezik (Engleski ili njemački) / Foreign language – English or German
	Diplomski rad / Master Thesis

Diplomski studij Oblikovanje proizvoda od drva

Graduate Study Programme Wood Product Design

Broj ECTS Semestar	1	2	3	4	5	6	7	8	9	10	11	12	13	14	15	16	17	18	19	20	21	22	23	24	25	26	27	28	29	30
1.	Konstrukcije proizvoda od drva / Constructions of Wooden Products 3 5 ECTS					Tehnološka priprema rada / Technological Production Management 5 ECTS					Pločasti materijali / Panel Materials 4 ECTS				Metodologija industrijskog oblikovanja/ Methodology of Industrial Design of Furniture 4 ECTS				Izborni predmet / Elective course 4 ECTS				Izborni predmet / Elective course 4 ECTS				Terenska nastava / Fieldwork 4 ECTS			
2.	Istraživanje fizikalnih i mehaničkih svojstava drva / Investigation of Physical and Mechanical Properties of Wood 5 ECTS					Drveni kompozitni materijali / Wood Composite Materials 5 ECTS					Osiguranje kakvoće finalnih proizvoda / Quality Assurance of Finished Products 4 ECTS				Sustavi informacija na tržištu drvnih proizvoda / Information systems in Wood Products Market 4 ECTS				Izborni predmet / Elective course 4 ECTS				Izborni predmet / Elective course 4 ECTS				Terenska nastava / Fieldwork 4 ECTS			
3.	Površinska obrada proizvoda od drva / Finishing of Wood Products 5 ECTS					Projektiranje proizvoda od drva / Designing of Wooden Products 5 ECTS					Namještaj i zdravlje / Furniture and Health 4 ECTS				Primjenjena statistika / Applied Statistics 4 ECTS				Izborni predmet / Elective course 4 ECTS				Izborni predmet / Elective course 4 ECTS				Terenska nastava / Fieldwork 4 ECTS			
4.	Diplomski rad / Master Thesis 30 ECTS																													

	Izborni predmeti 1. semestra. Biraju se 2. / Elective courses in the first semester.
	Izborni predmeti 2. semestra. Biraju se 2. / Elective courses in the second semester.
	Izborni predmeti 3. semestra. Biraju se 2. / Elective courses in the third semester.
	Diplomski rad / Master Thesis

Diplomski studij Drvnotehnološki procesi

Graduate Study Programme Wood Tecnology Processes

Broj ECTS Semestar	1	2	3	4	5	6	7	8	9	10	11	12	13	14	15	16	17	18	19	20	21	22	23	24	25	26	27	28	29	30
1.	Hidrotermička obrada drva / Hydrothermal Wood Processing 5 ECTS					Pilarska tehnologija drva II / Sawmilling Technology 2 5 ECTS					Kvantitativne metode za operacijska istraživanja / Quantitative Methods for Operations Research 4 ECTS				Proizvodni menadžment / Production Management 4 ECTS				Izborni predmet / Elective course 4 ECTS				Izborni predmet / Elective course 4 ECTS				Terenska nastava / Fieldwork 4 ECTS			
2.	Tehnologija furnira i uslojenog drva / Veneer and Plywood Technology 5 ECTS					Tehnologija ploča iz usitnjelog drva / Fragmented Wood Panels Technology 5 ECTS					Automatizacija i mjerna tehnika u DI / Automation and Measurement in Woodworking Industry 4 ECTS				Rukovanje materijalom / Material Handling 4 ECTS				Izborni predmet / Elective course 4 ECTS				Izborni predmet / Elective course 4 ECTS				Terenska nastava / Fieldwork 4 ECTS			
3.	Tehnologija drvnih proizvoda za graditeljstvo / Technology of Wood Building Components 5 ECTS					Tehnološki procesi površinske obrade drva / Processes of Wood Finishing 5 ECTS					Zaštita drva II / Wood Protection II 4 ECTS				Primjenjena statistika / Applied Statistics 4 ECTS				Izborni predmet / Elective course 4 ECTS				Izborni predmet / Elective course 4 ECTS				Terenska nastava / Fieldwork 4 ECTS			
4.	Diplomski rad / Master Thesis 30 ECTS																													

	Izborni predmeti 1. semestra. Biraju se 2. / Elective courses in the first semester.
	Izborni predmeti 2. semestra. Biraju se 2. / Elective courses in the second semester.
	Izborni predmeti 3. semestra. Biraju se 2. / Elective courses in the third semester.
	Diplomski rad / Master Thesis

Završni radovi i promocija prvostupnika

–

Bachelor's theses and bachelor graduation ceremony

Obranjen završni rad obično obilježava završetak trogodišnjega studiranja. Studenti prema svojim sklonostima za završne radove biraju područje i teme koje samostalno obrađuju i potvrđuju spremnost rješavanja stručnih zadataka. U akademskoj godini 2015./2016. diplomu prvostupnika/prvostupnice sveučilišnoga preddiplomskog studija steklo je 19 studenata, kojima je mentoriralo 11 nastavnika. Popis tema studenata govori o raznim njihovim interesima.

The defence of the Bachelor's thesis marks the end of the three-year baccalaureate programme. Students prepare their theses in a field of their interest on a topic they independently address, to confirm their readiness to take on professional tasks. In the 2015/2016 academic year, 19 students earned the diploma and title of baccalaureate in the undergraduate university study programme, under supervision of 11 mentors. The list of topics addressed by students shows the wide range of interests.

Autor: Marko Vidnić
Mentor: Doc. dr. sc. Bogoslav Šefc
Predmet: Anatomija drva
Naslov: Primjena računalnih programa u analizi stanica drva
Datum završetka studija: 29. 9. 2016.

Author: Marko Vidnić
Mentor: Assistant Professor Bogoslav Šefc, PhD
Subject: Wood Anatomy
Title: Application of computer programs for wood cell analysis
Date of finished study: 29/09/2016

Autor: Zrinka Bridić
Mentor: Prof. dr.sc. Vladimir Jambrekočić
Predmet: Ploče od usitnjenog drva
Naslov: Sorpcijska svojstva OSB ploča izloženih direktnom djelovanju vode
Datum završetka studija: 23. 9. 2016.

Author: Zrinka Bridić
Mentor: Professor Vladimir Jambrekočić, PhD
Subject: Fragmented Wood Panels
Naslov: Sorption properties of OSB boards exposed to direct impact of water
Date of finished study: 23/09/2016

Autor: Antonio Guliš
Mentor: Doc. dr. sc. Goran Mihulja
Predmet: Tehnologija finalne obrade drva
Naslov: Utjecaj veličine korisnog ostatka na iskorištenje kod raskrajanja drvnih ploča
Datum završetka studija: 23. 9. 2016.

Author: Antonio Guliš
Mentor: Goran Mihulja, PhD, Assistant Professor
Subject: Final Wood Processing
Title: Impact of waste elements size on the result of wood based panel dividing
Date of finished study: 23/09/2016

Autor: Ivan Lacković
Mentor: Prof. dr. sc. Tomislav Sinković
Predmet: Tehnička svojstva drva 2
Naslov: Tvrdća drva
Datum završetka studija: 23. 9. 2016.

Author: Ivan Lacković
Mentor: Professor Tomislav Sinković, PhD
Subject: Technical properties of wood 2
Title: Hardness of wood
Date of finished study: 23/09/2016

Autor: Haris Bešić
Mentor: Prof. dr. sc. Vladimir Jambrekočić
Predmet: Ploče od usitnjenog drva
Naslov: Sorpcijska svojstva OSB ploča izloženih djelovanju vodene pare
Datum završetka studija: 23. 9. 2016.

Author: Haris Bešić
Mentor: Professor Vladimir Jambrekočić, PhD
Subject: Fragmented Wood Panels
Title: Sorption properties of OSB boards exposed to impact of water vapour
Date of finished study: 23/09/2016

Autor: Tomislav Pipić
Mentor: Prof. dr. sc. Vladimir Jambrekočić
Predmet: Ploče od usitnjenog drva
Naslov: Mogućnosti primjene kore drva za proizvodnju ploča iverica
Datum završetka studija: 23/09/2016

Author: Tomislav Pipić
Mentor: Professor Vladimir Jambrekočić, PhD
Subject: Fragmented Wood Panels
Title: Possibilities for wood bark utilization for particleboard production
Date of finished study: 23/09/2016

Autor: Antonio Copak
Mentor: Doc. dr. sc. Vjekoslav Živković
Predmet: Drvo u graditeljstvu
Naslov: Utjecaj izbora materijala na toplinsku izolaciju prozora
Datum završetka studija: 23. 9. 2016.
Author: Antonio Copak
Mentor: Vjekoslav Živković, PhD, Assistant Professor
Subject: Wood as a Building Material
Title: Influence of the material choice to thermal performance of windows
Date of finished study: 23/09/2016

Autor: Melita Šomođi
Mentor: Doc. dr. sc. Zoran Vlaović
Predmet: Ojastučeni namještaj
Naslov: Materijali i oblikovnokonstruktivna rješenja ojastučenog naslonjača za odmor
Datum završetka studija: 29. 9. 2016.
Author: Melita Šomođi
Mentor: Zoran Vlaović, PhD, Assistant Professor
Subject: Upholstered Furniture
Title: Materials and design solutions of upholstered armchair for relaxation
Date of finished study: 29/09/2016

Autor: Domagoj Švajcer
Mentor: Prof. dr. sc. Darko Motik
Predmet: Trgovina drvom i drvnim proizvodima
Naslov: Distribucijski kanali u prodaji namještaja
Datum završetka studija: 23. 09. 2016
Author: Domagoj Švajcer
Mentor: Professor Darko Motik, PhD
Subject: Marketing of Wood Products
Title: Distribution channels in furniture sales
Date of finished study: 23/09/2016

Autor: Ivan Matošević
Mentor: Prof. dr. sc. Darko Motik
Predmet: Planiranje i obračun proizvodnje
Naslov: Kalkulacije u pojedinim tipovima proizvodnje u preradi drva i proizvodnji namještaja
Datum završetka studija: 29. 9. 2016.
Author: Ivan Matošević
Mentor: Professor Darko Motik, PhD
Subject: Production planning and calculations
Title: Calculations in certain types of wood processing and furniture manufacturing industry
Date of finished study: 29/09/2016

Autor: Andrija Živković
Mentor: Doc. dr. sc. Marin Hasan
Predmet: Tehnološke karakteristike drva
Naslov: Određivanje tvrdoće po Brinellu drva topole
Datum završetka studija: 23. 9. 2016.
Author: Andrija Živković
Mentor: Marin Hasan, PhD, Assistant Professor
Subject: Technycal Properties of Wood
Title: Determination of Brinell hardness of poplar wood
Date of finished study: 23/09/2016

Autor: Denis Svitlanović
Mentor: Prof. dr. sc. Vladimir Jambrekić
Predmet: Ploče od usitnjenog drva
Naslov: Svojstva ploča iverica izrađenih iz acetilirane drvne sirovine
Datum završetka studija: 23. 9. 2016.
Author: Denis Svitlanović
Mentor: Professor Vladimir Jambrekić, PhD
Subject: Oriented strand boards
Title: Properties of particleboards from acetylated wood
Date of finished study: 23/09/2016

Autor: Anđela Vuković
Mentor: Prof. dr. sc. Darko Motik
Predmet: Trgovina drvom i drvnim proizvodima
Naslov: Prikaz stanja hrvatske prerade drva i proizvodnje namještaja primjenom sekundarnih izvora podataka
Datum završetka studija: 29. 9. 2016.
Autor: Anđela Vuković
Mentor: Professor Darko Motik, PhD
Subject: Trade in wood and wood products
Title: Review of Croatian wood processing and furniture manufacturing industry using secondary data sources
Date of finished study: 29/09/2016

Autor: Filip Veselčić
Mentor: Prof. dr. sc. Tomislav Sinković
Predmet: Tehnička svojstva drva 2
Naslov: Određivanje čvrstoće na tlak paralelno s vlakancima kod topolovine
Datum završetka studija: 16. 9. 2016.
Author: Filip Veselčić
Mentor: Professor Tomislav Sinković, PhD
Subject: Technological properties of wood 2
Title: Determination of the compressive strength parallel to the grain of poplar wood
Date of finished study: 16/09/2016

Autor: Igor Vicković
Mentor: Prof. dr. sc. Darko Motik
Predmet: Trgovina drvom i drvnim proizvodima
Naslov: Odluka potrošača – drvena građevna stolarija: DA ili NE
Datum završetka studija: 16. 9. 2016.
Author: Igor Vicković
Mentor: Professor Darko Motik, PhD
Subject: Trade in wood and wood products
Title: Customer decision – wood building joinery: YES or NO
Date of finished study: 16/09/2016

Autor: Helena Borković
Mentor: Doc. dr. sc. Vjekoslav Živković
Predmet: Drvo u graditeljstvu
Naslov: Utjecaj građevnih materijala na akustičku kvalitetu interijera
Datum završetka studija: 16. 9. 2016.
Author: Helena Borković
Mentor: Vjekoslav Živković, PhD, Assistant Professor
Predmet: Wood in construction
Title: Influence of the building material to indoor acoustic quality
Date of finished study: 16/09/2016

Autor: Juraj Stanešić
Mentor: Doc. dr. sc. Alan Antonović
Predmet: Kemija drva
Naslov: Piroлиза klona bijele topolovine (*Populus alba*): karakterizacija bioulja i biougljena
Datum završetka studija: 16. 9. 2016.
Author: Juraj Stanešić
Mentor: Alan Antonović, PhD, Assistant Professor
Subject: Chemistry of wood
Title: Pyrolysis of white poplar clone (*Populus Alba*): bio-oil and bio-char characterization
Date of finished study: 16/09/2016

Autor: Tin Lojen
Mentor: Prof. dr. sc. Stjepan Risović
Predmet: Drvnoindustrijsko strojarstvo
Naslov: Ovisnost dimenzionalne stabilnosti drvnih paleta o temperaturi prešanja i dodacima
Datum završetka studija: 1. 7. 2016.
Author: Tin Lojen
Mentor: Professor Stjepan Risović, PhD
Subject: Wood industry machining
Title: Influence of pressing temperature and additives on dimensional stability of wood pellets
Date of finished study: 01/07/2016

Autor: Bruno Rezo

Mentor: Doc. dr. sc. Goran Mihulja

Predmet: Tehnologija finalne obrade drva

Naslov: Tehnologija raskrajanja ploča

Datum završetka studija: 1. 7. 2016.

Author: Bruno Rezo

Mentor: Goran Mihulja, PhD, Assistant Professor

Subject: Technology of final wood processing

Title: Panel cutting technology

Date of finished study: 01/07/2016

Haris Bešić

Sorpcijska svojstva OSB ploča izloženih djelovanju vodene pare

Sorption properties of OSB boards exposed to the impacts of water vapour

Type of work: Bachelor thesis

Autor: Zrinka Bridić

Mentor: Vladimir Jambreko*vić*, PhD, Professor

Naslov: Sorption properties of OSB boards exp

Vrsta rada: Završni rad

Autor: Haris Bešić

Mentor: Prof. dr. sc. Vladimir Jambreko*vić*

Naslov: Sorpcijska svojstva OSB ploča izloženih djelovanju vodene pare

U ovome završnom radu laboratorijski su utvrđena sorpcijska svojstva OSB ploča. Svojstva ploča utvrđena su na osnovi razlika vrijednosti mase i debljine uzoraka prije i nakon njihovog izlaganja u atmosferi zasićenoj vodenom parom. Radi utvrđivanja dominantnoga puta prodiranja vode u strukturu ploča, brtvilo na bazi epoksidne smole nanoseno je na rubove, odnosno plohe (lice i naličje) ispitnih uzoraka. Rezultati ispitivanja upućuju na dominantan efekt upijanja vode iz atmosfere zasićene vodenom parom preko rubova ploča.

Type of work: Bachelor thesis

Author: Haris Bešić

Mentor: Prof. dr. sc. Vladimir Jambreko*vić*

Title: Sorption properties of OSB boards exposed to the impacts of water vapour

The sorption properties of OSB boards were determined by means of laboratory testing. Properties were determined based on the difference of mass and thickness of panel samples before and after exposure to an atmosphere saturated with water vapour. In order to determine the dominant path of water penetration into the board structure, epoxy based sealant was applied to the edges or surfaces (front and back) of test samples. The test results indicate the dominant effect of water absorption from a water-vapour saturated atmosphere through the board edges.



Netretirani uzorak OSB ploče i uzorci plošno i rubno tretirani epoksidnim brtvilom
Untreated OSB board sample and samples with edges and surfaces treated with epoxy sealant



Zrinka Bridić

Sorpcijska svojstva OSB ploča izloženih direktnom djelovanju vode

Sorption properties of OSB boards exposed to the direct impacts of water

Vrsta rada: Završni rad

Autor: Zrinka Bridić

Mentor: Prof. dr. sc. Vladimir Jambreković

Naslov: Sorpcijska svojstva OSB ploča izloženih direktnom djelovanju vode

U ovome završnom radu laboratorijski su utvrđena sorpcijska svojstva OSB ploča. Svojstva ploča utvrđena su na osnovi razlika vrijednosti mase i debljine uzoraka prije i nakon njihova izlaganja u atmosferi zasićenoj vodenom parom. Radi utvrđivanja dominantnoga puta prodiranja vode u strukturu ploča, brtvilo na bazi epoksidne smole nanoseno je na rubove, odnosno plohe (lice i naličje) ispitnih uzoraka. Rezultati ispitivanja upućuju na dominantan efekt upijanja vode iz atmosfere zasićene vodenom parom preko rubova ploča.

Type of work: Bachelor thesis

Autor: Zrinka Bridić

Mentor: Vladimir Jambreković, PhD, Professor

Title: Sorption properties of OSB boards exposed to the direct impact of water

In addition to the different additives used during their production, the expansion of usage potential of boards made from fragmented wood is also achieved through the use of wood in various forms, thus creating boards composed of micro- and macro- wood chips. Boards made from oriented wood strands (chips) that belong in the latter group were used in this study. More precisely, the sorption properties of oriented strand boards (OSB) directly exposed to the influence of water were determined. Furthermore, the effect of sealing the board sample edges/surfaces on water absorption, thickness swelling, water content and change in board density were also determined.



Odvajanje iverja s površine
plošno zaštićenoga uzorka OSB ploče

Separation of wood chips from the surface
of a flat protected OSB board sample

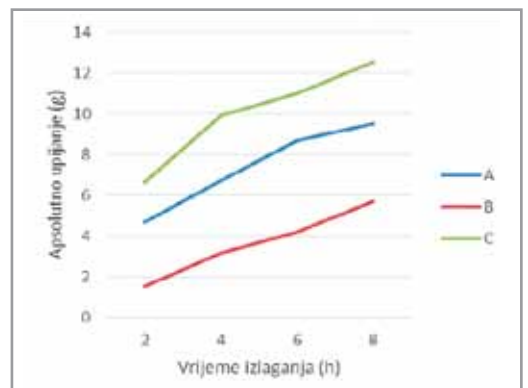
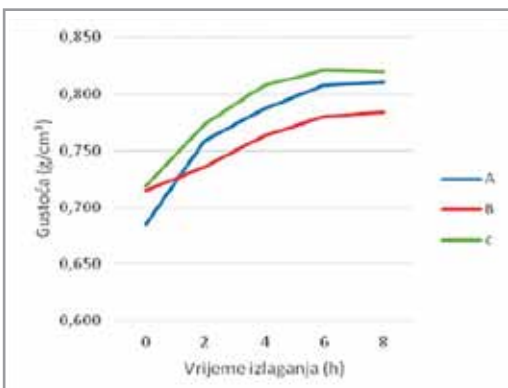

Ivan Lacković

Tvrdoća drva

Hardness of wood

Vrsta rada: Završni rad

Autor: Ivan Lacković

Mentor: Izv. prof. dr. sc. Tomislav Sinković

Naslov: Tvrdoća drva

U ovome je završnome radu obrađena tema tvrdoće drva, s posebnim naglaskom na metode utvrđivanja tvrdoće i razlika u tvrdoćama pojedinih vrsta drva. Prikazane su prednosti i nedostaci metoda na temelju istraživanja samih autora pojedinih metoda. U radu su pojašnjene metode određivanja tvrdoće na trima osnovnim presjecima (poprečnome, radijalnome i tangencijalnome).

Type of work: Bachelor thesis

Author: Ivan Lacković

Mentor: Tomislav Sinković, PhD, Associate Professor

Subject: Hardness of wood

This thesis addresses the topic of the hardness of wood, with special emphasis on the methods for determining hardness and the differences in the hardness of certain types of wood. There are advantages and disadvantages to each of the methods as shown in the study. The method for determining hardness of the three main sections (transverse, radial and tangential) is explained.



	MEKANO	SREDNJE	TVRDO	TVRDOĆA JANKA
JATOBA				2350
MAHAGONIJ				1980
MERBAU				1925
DOUSSIE				1810
WENGE				1630
BAGREM				1600
JAVOR USA				1450
HRAST				1360
BUKVA				1350
JASEN				1320
RED OAK				1290
IROKO				1260
JAVOR EU				1238
ORAH				1010
TREŠNJA				950
BREZA				910



Tomislav Pipić

Mogućnosti primjene kore drva za proizvodnju ploča iverica

Possibilities for wood bark utilization in particleboard production

Vrsta rada: Završni rad

Autor: Tomislav Pipić

Mentor: Prof. dr. sc. Vladimir Jambreko

Naslov: Mogućnosti primjene kore drva za proizvodnju ploča iverica

Iako se pri proizvodnji ploča iverica iz drva kora u pravilu odvaja, dugogodišnja istraživanja velikog broja istraživača pokazala su dva smjera moguće primjene kore za proizvodnju ploča iverica. To su proizvodnja ploča iz kore bez dodatka sintetskoga veziva i uz dodatak sintetskoga veziva. S obzirom na to da je u literaturi dostupan cijeli niz podataka o metodama izrade i svojstvima ploča iverica izrađenima iz kore, u ovome su završnom radu oni sumirani i sustavno obrađeni.

Type of work: Bachelor's thesis

Author: Tomislav Pipić

Mentor: Professor Vladimir Jambreko, PhD

Title: Possibilities for wood bark utilization in particleboard production

While bark is usually separated during particleboard production, many authors have suggested two possible directions of its use in particleboard production, i.e. with and without the addition of synthetic binders. The literature provides sufficient data on production methods and properties of particleboards produced by using bark, and this thesis gives a summary and analysis of research to date.

Dijagram postupka izrade ploča iverica iz kore bez dodatka veziva
Diagram of the process of producing particleboards from bark without the addition of binders

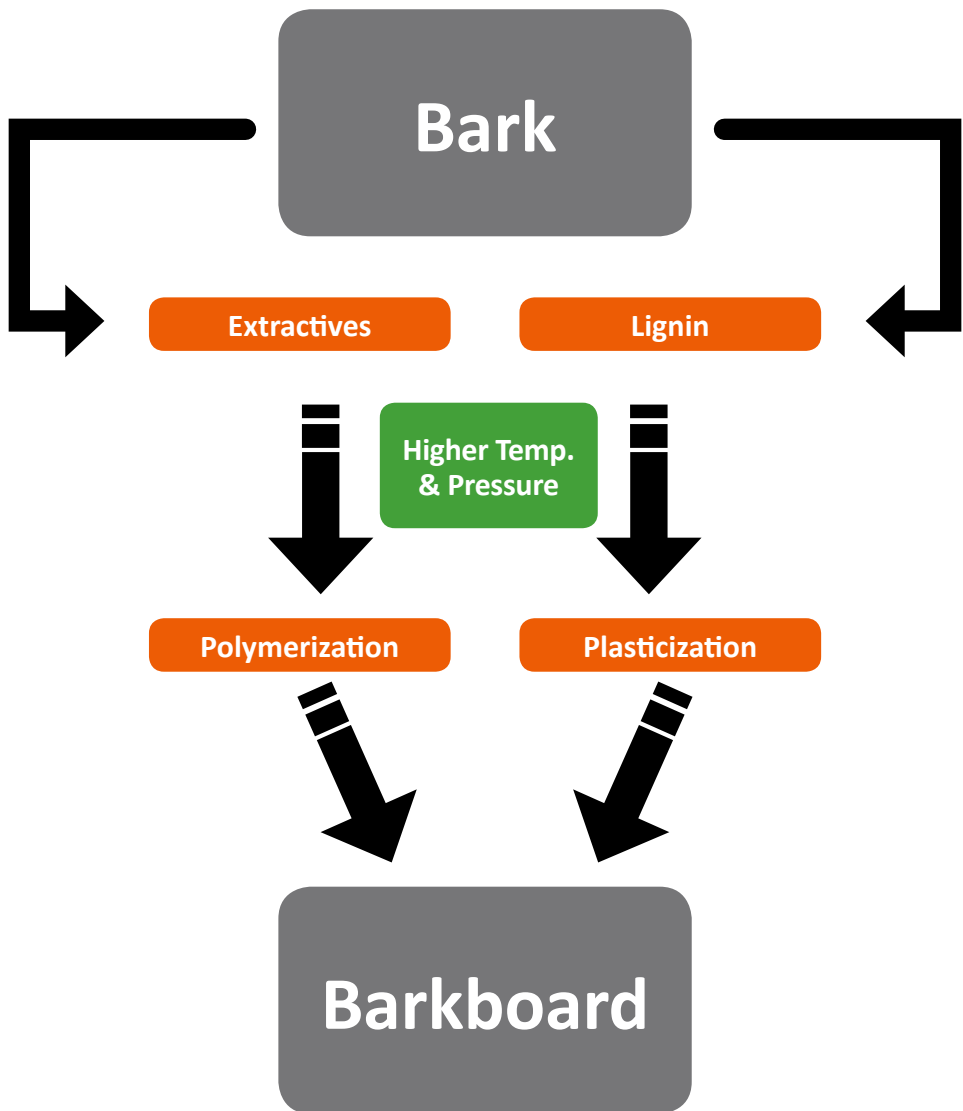

Denis Svilanović

Svojstva ploča iverica izrađenih iz acetilirane drvene sirovine
Properties of particleboards made from acetylated wood

Vrsta rada: Završni rad

Autor: Denis Svitlanović

Mentor: Prof. dr. sc. Vladimir Jambreković

Naslov: Svojstva ploča iverica izrađenih iz acetilirane drvene sirovine

Acetilacija je relativno jednostavan kemijski proces modifikacije drva, kojim se postiže povećana njegova trajnost u nepovoljnim uvjetima korištenja, i stoga je vrlo zanimljiva s aspekta izrade kompozitnih materijala veće dimenzijske stabilnosti. U novije vrijeme objavljen je velik broj radova na temu primjene acetiliranoga drvnog iverja za proizvodnju ploča iverica. Stoga je u ovome završnom radu napravljen pregled osnovnih podataka o postupcima acetilacije i svojstvima ploča izrađenih primjenom acetilirane drvene sirovine.

Type of work: Bachelor's thesis

Author: Denis Svitlanović

Mentor: Professor Vladimir Jambreković, PhD

Title: Properties of particleboards made from acetylated wood

Acetylation is a relatively simple chemical process of wood modification that improves its durability in unfavourable conditions of use. Therefore, it is very interesting for the production of composite materials having a greater dimensional stability. Recently, many authors have addressed the possibility of using acetylated wood chips in particleboard production. Therefore, this thesis provides an overview of the basics of the acetylation process and properties of boards produced from acetylated wood raw material.

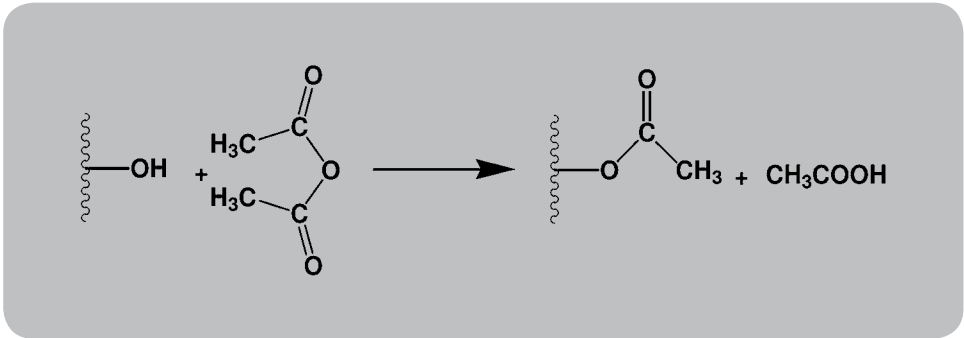

Reakcijska shema acetilacije anhidridom octene kiseline*
Reaction scheme of acetylation using acetic anhydride



Filip Veseličić

Određivanje čvrstoće na tlak paralelno s vlakancima kod topolovine

Determination of the compressive strength parallel to the grain of poplar wood

Vrsta rada: Završni rad

Autor: Filip Veseličić

Mentor: Izv. prof. dr. sc. Tomislav Sinković

Naslov: Određivanje čvrstoće na tlak paralelno s vlakancima kod topolovine

U radu je provedeno ispitivanje čvrstoće na tlak paralelno s vlakancima drva klona topole (*Populus alba L-12*) i bijele topole (*Populus alba L.*). Čvrstoća na tlak pratila se kroz godine, od srca prema kori. Tako se utvrdila radijalna distribucija čvrstoće na tlak paralelno s vlakancima. Uz radijalnu distribuciju ispitan je i utjecaj gustoće drva na čvrstoću na tlak.

Type of work: Bachelor's thesis

Author: Filip Veseličić

Mentor: Tomislav Sinković, PhD, Associate Professor

Title: Determination of the compressive strength parallel to the grain of poplar wood

This study tested the compressive strength parallel to the grain of wood poplar clones (*Populus alba L-12*) and white poplar (*Populus alba L.*). Compressive strength is monitored through the rings from the heartwood to the bark to determine the radial distribution of the compressive strength parallel to the grain. In addition to the radial distribution, the influence of wood density on compression strength was also tested.

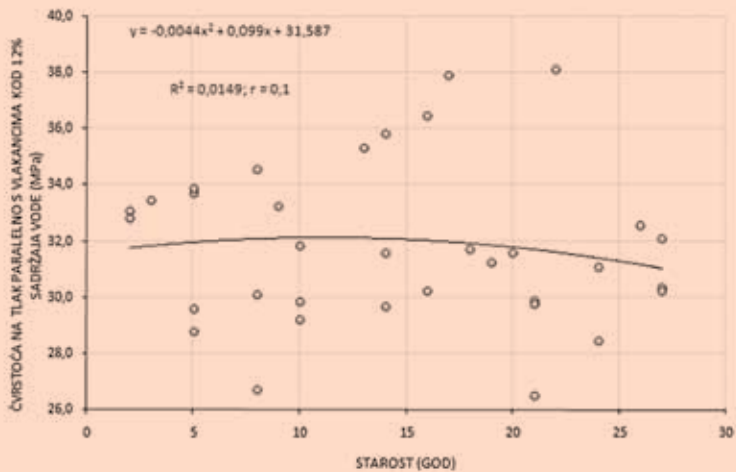

Granica goda

God

Diplomski radovi i promocija magistara inženjera

–

Master's theses and graduation ceremony

Diploma s titulom magistra inženjera drvne tehnologije stječe se nakon završenoga diplomskog studija. 26. 11. 2016. diplomu s titulom magistra inženjera drvne tehnologije – oblikovanje proizvoda od drva – primilo je 12 studenata, a magistra inženjera drvne tehnologije – drvnotehnološki procesi – primilo je 14 studenata.

Da je riječ o uspješnoj generaciji govori i podatak o ukupno 11 pohvala koje su uručene uz diplome i visoke prosječne ocjene ostvarene na studiju. Pohvale *Cum Laude* primili su Ivan Matušin (4,508), Krešimir Balaško (4,5) i Jure Beljo (4,517) sa završenim diplomskim studijem Drvnotehnološki procesi te Andrea Begović (4,65) sa završenim diplomskim studijem Oblikovanje proizvoda od drva, koji je iznjedrilo i ostale dobitnike velike i najveće pohvale. Veliku pohvalu *Magna Cum Laude* primili su Lucija Brglez (4,825), Martino Grgić (4,692), Karla Harazim (4,817), Lana Jarža (4,823) i Kristina Marić (4,767). Najveću pohvalu *Summa Cum Laude* primile su Margareta Kovačević (4,842) i Ana Mišetić (4,858).

The diploma and title of Master Engineer of Wood Technology is granted following the completion of the graduate study programme. On 26th November 2016, a total of 12 students were granted the diploma with the title of Master Engineer of Wood Technology – Wood Product Design, and 14 students were granted the diploma with the title of Master Engineer of Wood Technology – Wood Technology Processes.

This was a very successful generation, as seen by the 11 awards of merit given with the diplomas, and the high-grade point averages achieved in the study programme. Honours (*Cum Laude*) were bestowed upon Ivan Matušin (4.508), Krešimir Balaško (4.5) and Jure Beljo (4.517) with the completed Wood Technology Processes graduate programme, and Andrea Begović (4.65) with the completed Wood Product Design graduate programme. The latter programme also gave the remaining winners of honours. Great honours (*Magna Cum Laude*) were bestowed upon Lucija Brglez (4.825), Martino Grgić (4.692), Karla Harazim (4.817), Lana Jarža (4.823) and Kristina Marić (4.767). The highest honours (*Summa Cum Laude*) were bestowed upon Margareta Kovačević (4.842) and Ana Mišetić (4.858).

Oblikovanje proizvoda od drva

Wood product design

Autor: Danijela Gadže

Predmet: Pločasti materijali

Mentor: Prof. dr. sc. Vladimir Jambreko

Naslov: Sorpcijska svojstva komercijalnog drvno-plastičnog kompozita na bazi poli(vinil-klorida)

Datum završetka studija: 29. 9. 2016.

Author: Danijela Gadže

Subject: Panel materials

Mentor: Professor Vladimir Jambreko, PhD

Title: Sorption properties of commercial poly(vinyl chloride) based wood plastic composite

Date of finished study: 29/09/2016

Auto: Lana Jarža

Predmet: Projektiranje proizvoda od drva

Mentor: Izv. prof. dr. sc. Silvana Prekrat

Naslov: Razvoj drvene radne stolice

Datum završetka studija: 23. 9. 2016.

Author: Lana Jarža

Subject: Designing of Wooden Products

Mentor: Silvana Prekrat, PhD, Associate Professor

Title: Product development of wooden work chair

Date of finished study: 23/09/2016

Autor: Andrea Begović

Predmet: Namještaj i opremanje prostora

Mentor: Doc. dr. sc. Danijela Domljan

Naslov: Opremanje prostora za odmor u zgradama za odgoj i obrazovanje

Datum završetka studija: 23. 9. 2016.

Author: Andrea Begović

Subject: Furniture and Interior Decoration

Mentor: Danijela Domljan, PhD, Assistant Professor

Title: Equipping spaces for rest in the educational institutions

Date of finished study: 23/09/2016

Autor: Lucija Brglez

Predmet: Pločasti materijali

Mentor: Prof. dr. sc. Vladimir Jambreko

Naslov: Povećanje estetskih svojstava drvnih ploča kao rezultat bojenja drvnog iverja

Datum završetka studija: 23. 9. 2016.

Author: Lucija Brglez

Subject: Panel materials

Mentor: Professor Vladimir Jambreko, PhD

Title: Enhancement of wood based panels aesthetic properties as a result of wood chip staining

Date of finished study: 23/09/2016

Autor: Ana Buvač

Predmet: Upravljanje projektima

Mentor: Prof. dr. sc. Denis Jelačić

Naslov: Analiza elemenata upravljanja projekta izgradnje kuće od trupaca na području sjeverne Amerike

Datum završetka studija: 23. 9. 2016.

Author: Ana Buvač

Subject: Project management

Mentor: Professor Denis Jelačić, PhD

Title: Analysis of project elements for log houses construction in North America region

Date of finished study: 23/09/2016

Autor: Margareta Kovačević
Predmet: Metodologija industrijskog oblikovanja namještaja
Mentor: Doc. dr. sc. Danijela Domljan
Naslov: Oblikovanje suvremenog namještaja temeljenog na tradiciji i baštini
Datum završetka studija: 23. 9. 2016.
Author: Margareta Kovačević
Subject: Methodology of Industrial Design of Furniture
Mentor: Danijela Domljan, PhD, Assistant Professor
Title: Design of contemporary furniture based on tradition and heritage
Date of finished study: 23/09/2016

Autor: Kristina Marić
Predmet: Namještaj i zdravlje
Mentor: Doc. dr. sc. Zoran Vlaović
Naslov: Istraživanje vodljivosti topline i propusnosti vlage kod madraca s džepičastom opružnom jezgrom
Datum završetka studija: 23. 9. 2016.
Author: Kristina Marić
Subject: Furniture and health
Mentor: Zoran Vlaović, PhD, Assistant Professor
Title: Research of heat conductivity and moisture permeability through mattress with pocket spring core
Date of finished study: 23/09/2016

Autor: Ana Mišetić
Predmet: Površinska obrada proizvoda od drva
Mentor: Professor Vlatka Jirouš Rajković, PhD
Naslov: Postojanost poliuretanskog laka iz utekućenog drva pri ubrzanom izlaganju ultraljubičastom zračenju
Datum završetka studija: 23. 9. 2016.
Author: Ana Mišetić
Subject: Surface processing of wood products
Mentor: Professor Vlatka Jirouš Rajković, PhD
Title: Durability of polyurethane varnish from liquefied wood at accelerated exposure to ultraviolet radiation
Date of finished study: 23/09/2016

Autor: Karla Harazim
Predmet: Namještaj i zdravlje
Mentor: Prof. dr. sc. Ivica Grbac/ Professor Ivica Grbac, PhD
Naslov: Utjecaj stavova korisnika na prevenciju zdravlja u staračkim domovima
Datum završetka studija: 23. 9. 2016.
Author: Karla Harazim
Subject: Furniture and Health
Mentor: Professor Ivica Grbac, PhD
Title: The impact of users' attitudes on health prevention in nursing homes
Date of finished study: 23/09/2016

Autor: Martino Grgić
Predmet: Konstrukcije proizvoda od drva III
Mentor: Ivica Župčić, PhD, Assistant Professor
Naslov: Istraživanje izvlačne čvrstoće T-sastava kod plošnog sastavljanja korpurnog namještaja
Datum završetka studija: 9. 9. 2016.
Author: Martino Grgić
Subject: Constructions of Wooden Products 3
Mentor: Ivica Župčić, PhD, Assistant Professor
Title: Research on tensile strength T joints in angled blade assembly of the corpus furniture
Date of finished study: 09/09/2016

Autor: Ante Dučić
Predmet: Tehnološka priprema rada
Mentor: Prof. dr. sc. Denis Jelačić
Naslov: Tehnološka priprema rada kao dio upravljačkog sustava poduzeća
Datum završetka studija: 9. 9. 2016.
Author: Ante Dučić
Subject: Technological Production Management
Mentor: Professor Denis Jelačić, PhD
Title: Technological production management as a part of enterprise management system
Date of finished study: 09/09/2016

Autor: Ivan Zec

Predmet: Upravljanje projektima

Mentor: Prof. dr. sc. Denis Jelačić

Naslov: Projektna struktura u različitim upravljačkim sustavima poduzeća

Datum završetka studija: 1. 7. 2016.

Author: Ivan Zec

Subject: Project management

Mentor: Professor Denis Jelačić, PhD

Title: Project structure in different management systems of companies

Date of finished study: 1/7/2016.

Andrea Begović

Opremanje prostora za odmor u zgradama za odgoj i obrazovanje
Equipping spaces for rest in the educational institutions

Vrsta rada: Diplomski rad

Autor: Andrea Begović

Mentor: Doc. dr. sc. Danijela Domljan

Naslov: Opremanje prostora za odmor u zgradama za odgoj i obrazovanje

Suvremene potrebe i načini opremanja zgrada za odgoj i obrazovanje predviđaju prostore za odmor i kreativan rad učenika i studenata. Cilj je rada istražiti i dokazati imaju li se učenici i studenti odgovarajućim prostorom za odmor, druženje, učenje i rad u postojećim srednjim školama i fakultetima Grada Zagreba i Virovitičko-podravске županije. Metodama anketiranja, promatranja, intervjua, fotografiranja i usporedbe rezultata s promatranih poligona utvrđeno je trenutno stanje opremljenosti te razina zadovoljstva korisnika pri uporabi takvih prostora i namještaja u njemu. Na temelju dobivenih rezultata predložena su nova oblikovna rješenja prostora te namještaja i opreme koji su u skladu sa suvremenim potrebama korisnika.

Type of work: Master's Thesis

Author: Andrea Begović

Mentor: Danijela Domljan, PhD, Assistant Professor

Title: Equipping spaces for rest in the educational institutions

Contemporary needs and methods of furnishing educational institutions should provide leisure areas for the creative work of students. The aim of the study was to examine and prove whether students have an appropriate place for relaxing, socialising, learning and working in observed secondary schools and faculties in the cities of Zagreb and Virovitica-Podravina Counties. Through methods of surveys, observation, interviews, photographing and comparison of results with the observed polygons, the current status of equipment and level of user satisfaction in using such spaces and the furniture within was established. Based on the results, new design solutions of space, furniture and equipment in line with the contemporary needs of the user were presented.

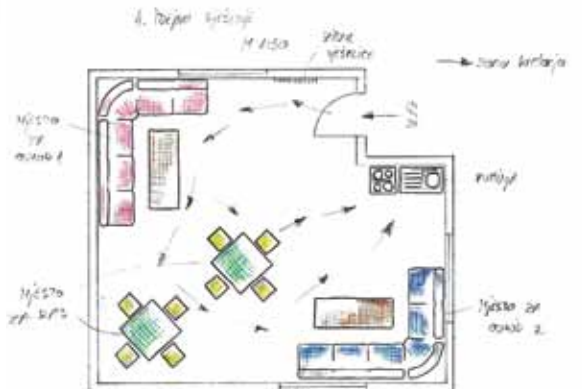
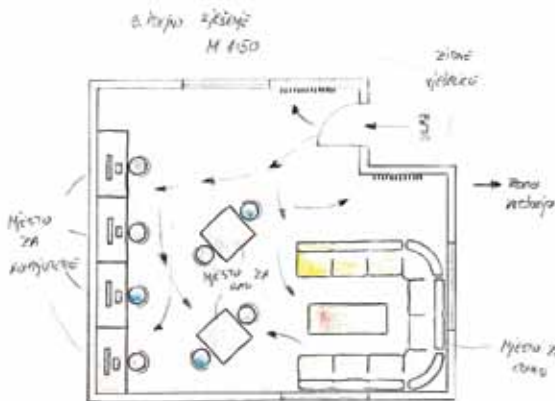
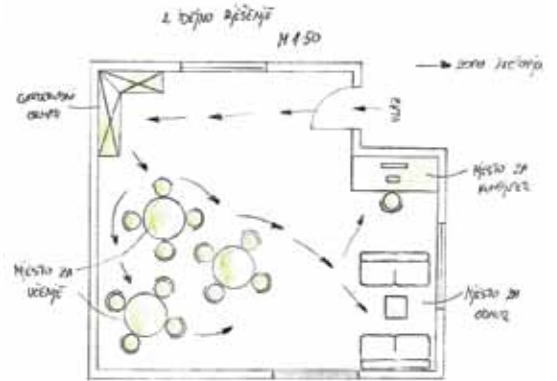
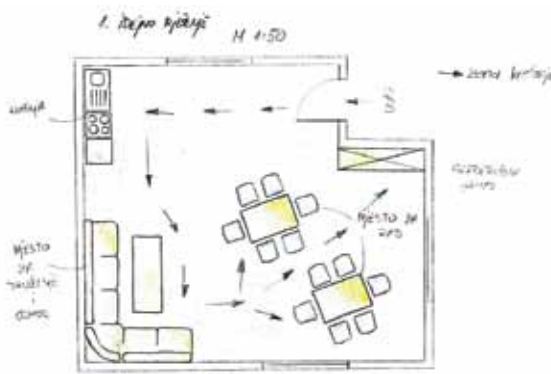

Lucija Brglez

Povećanje estetskih svojstava drvnih ploča kao rezultat bojenja drvnog iverja
Enhancement of wood based panels aesthetic properties as a result of wood chip staining

Vrsta rada: Diplomski rad

Autor: Lucija Brglez

Mentor: Prof. dr. sc. Vladimir Jambreko

Naslov: Povećanje estetskih svojstava drvnih ploča kao rezultat bojenja drvnog iverja

Iz prethodno obojenoga strand iverja u eksperimentalnome dijelu ovoga diplomskog rada izrađene su jednoslojne ploče iverice i utvrđena su njihova fizikalno-mehanička svojstva. Rezultati ispitivanja pokazali su da ploče izrađene iz prethodno obojenoga iverja imaju zadovoljavajuća fizikalno-mehanička svojstva, bolja estetska svojstva, ali i izraženo visoke koncentracije slobodnoga formaldehida. Stoga je glavni zaključak ovoga rada taj da se bojenjem iverja i njegovom primjenom mogu proizvesti vrlo zanimljivi pločasti materijali, ali se pritom mora paziti na usklađenost parametara izrade s karakteristikama, u proizvodnji primijenjenih kemijskih sirovina.

Type of work: Master's Thesis

Author: Lucija Brglez

Mentor: Vladimir Jambreko, PhD, Professor

Title: Enhancement of wood based panels aesthetic properties as a result of wood chip staining

In the experimental part of this thesis, single layer particleboards were produced from prestained wood (strand) chips and their physical and mechanical properties were determined. Test results showed that boards produced using prestained wood chips have satisfactory physical and mechanical properties and improved aesthetic qualities, but also that they have high free formaldehyde concentrations. Therefore, the main conclusion of this study was that it is possible to produce very interesting board materials through wood chip staining and their utilization. However, great attention must be placed on the compatibility of board production parameters with characteristics of chemical raw materials used in production.

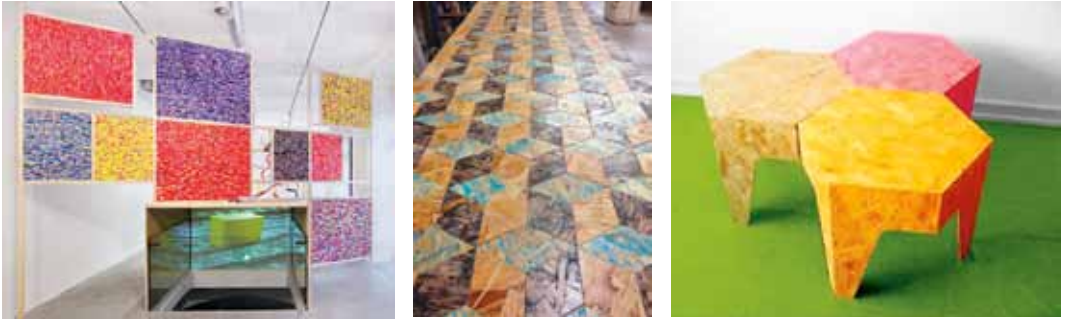

Danijela Gadže

Sorpcijska svojstva komercijalnog drvno-plastičnog kompozita na bazi poli (vinil-klorida)
Sorption properties of commercial poly(vinyl chloride) based wood plastic composite

Vrsta rada: Diplomski rad

Autor: Danijela Gadže

Mentor: Prof. dr. sc. Vladimir Jambreković

Naslov: Sorpcijska svojstva komercijalnog drvno-plastičnog kompozita na bazi poli(vinil-klorida)

Vrlo je često razmišljanje da je drvo u strukturi drvno-plastičnih kompozita u potpunosti zaštićeno i da ne bubri u doticaju s vodom. Kako je realna situacija gotovo u potpunosti suprotna, bitno je poznavati sorpcijske karakteristike materijala. Točnije, odnose vremena izlaganja i promjene sadržaja vode i debljine kompozita izloženoga djelovanju vode. Eksperimentalno utvrđivanje navedenih relacija bio je cilj ovoga rada. Njegovi su rezultati pokazali da temperatura izlaganja ima važan utjecaj na sorpcijska svojstva kompozita izrađenog iz poli(vinil-klorida).

Type of work: Master's Thesis

Author: Danijela Gadže

Mentor: Professor Vladimir Jambreković, PhD

Title: Sorption properties of commercial poly(vinyl chloride) based wood plastic composite

It is often considered that in the structure of wood-plastic composite, the wood is completely protected and that it does not swell in contact with water. As the reality is completely opposite it is therefore important to know the material sorption properties, as the relationship between exposure time and changes in water contents and thickness of composites exposed to water. This study included an experimental determination of those relations, and its results demonstrated that exposure temperature has a significant influence on the sorption characteristics of poly(vinyl-chloride) based composite.

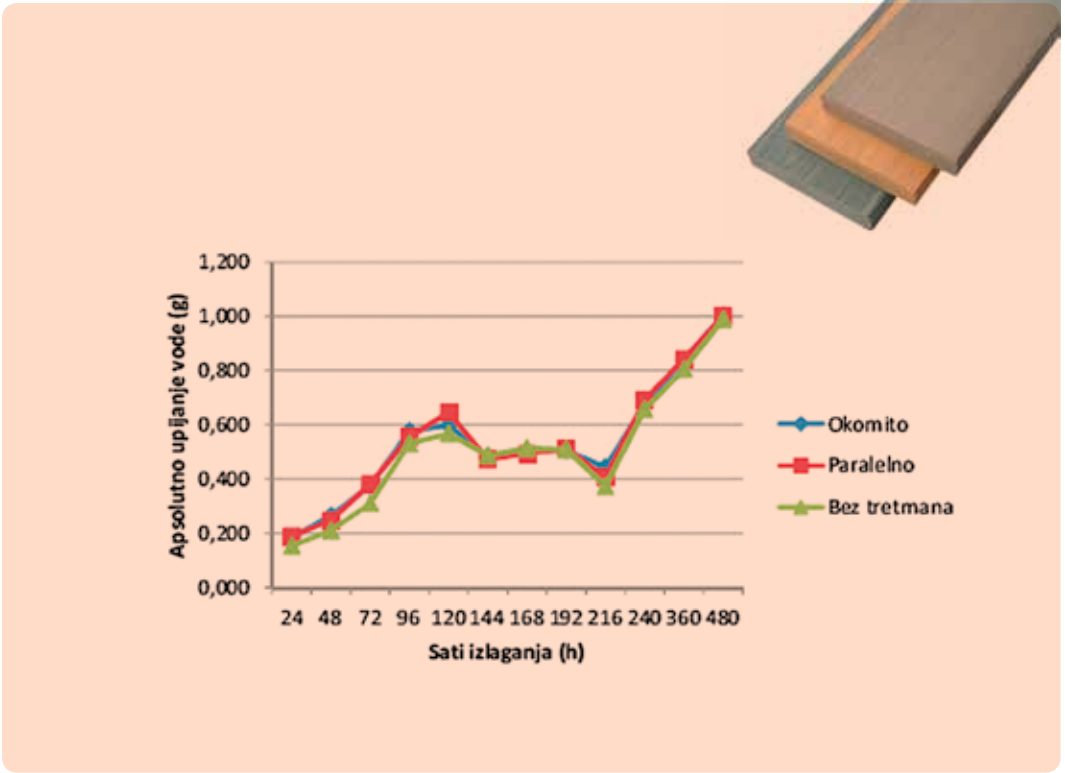

Martino Grgić

Istraživanje izvlačne čvrstoće T-sastava kod plošnog sastavljanja korpusnog namještaja

Research on tensile strength T-joints in angled blade assembly of the corpus furniture

Vrsta rada: Diplomski rad

Autor: Martino Grgić

Mentor: Doc. dr. sc. Ivica Župčić

Naslov: Istraživanje izvlačne čvrstoće T-sastava kod plošnog sastavljanja korpusnog namještaja

U radu je istražen utjecaj sastavnoga elementa na izvlačnu čvrstoću konstrukcijskih sastava koji se rabe kod korpusnog namještaja. Za istraživanje izrađeni su uzorci od ploča iverice i srednje teške vlaknatice koji se sastoje od dvaju dijelova. Dimenzije su plošnoga elementa $120 \times 65 \times 18$ mm, a dimenzije čeonoga $120 \times 80 \times 18$ mm; elementi su spojeni kutno-plošnim T-sastavom. Za istraživanje je korišteno šest vrsta sastavnih elemenata: moždanici, "Lamello" i "Lamelica" umetci te vezni elementi "Tenso P-14", "Clamex P-14" i "Divario P-18". Dobiveni su rezultati istraživanja statistički obrađeni te služe kao pokazatelj o tome koji je od sastavnih elemenata optimalan pri spajanju korpusnoga namještaja.

Type of work: Master's Thesis

Author: Martino Grgić

Mentor: Ivica Župčić, PhD, Assistant Professor

Title: Research on tensile strength T-joints in angled blade assembly of the corpus furniture

This study examined the influence of the connecting element on tensile strength of the structural composition used in corpus furniture. Samples were constructed of particle-board and a two-part, medium density fibreboard. Dimensions of the plate element were $120 \times 65 \times 18$ mm, and the dimensions of the front $120 \times 80 \times 18$ mm, and elements were connected with T-shaped middle joints. This study analysed six types of fasteners: dowels, elliptical Lamello and Lamelica inserts and the connectors "Tenso P-14", "Clamex P-14" and "Divario P-18". The results were statistically analysed and gave an overview of which connecting elements were optimal for connecting corpus furniture.

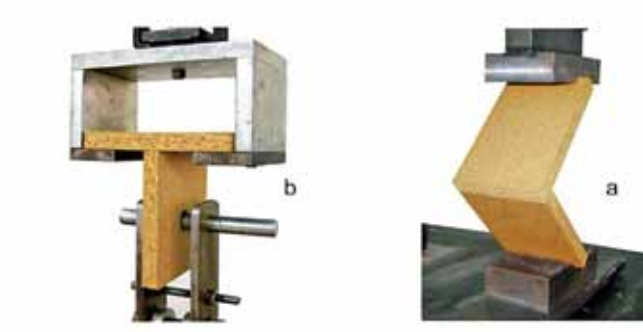

Karla Harazim

Utjecaj stavova korisnika na prevenciju zdravlja u staračkim domovima

The impact of users attitudes on health prevention in nursing home

Vrsta rada: Diplomski rad

Autor: Karla Harazim

Mentor: Prof. dr. sc. Ivica Grbac

Naslov: Utjecaj stavova korisnika na prevenciju zdravlja u staračkim domovima

U radu se istraživao utjecaj oblikovno-konstruktivskih rješenja namještaja na zdravlje korisnika u trećoj životnoj dobi u domovima za starije i nemoćne osobe (tzv. starački domovi). Kroz analizu i usporedbu primjera postojećih rješenja namještaja kojima su opremljeni domovi u Republici Češkoj i Republici Hrvatskoj definirani su zahtjevi i kriteriji na kvalitetu namještaja koji omogućava zdravstvenu prevenciju korisnika. Cilj rada bio je metodama ankete i intervjuja ustanoviti razinu zadovoljstva korisnika, te metodom promatranja i fotografiranja potvrditi kvalitetu oblikovno-konstruktivskih rješenja postojećega namještaja u navedenim objektima objiju Republika.

Type of work: Master's Thesis

Author: Karla Harzim

Mentor: Ivica Grbac, PhD, Professor

Title: The impact of users attitudes on health prevention in nursing home

This study analyses the impacts of design and construction solutions of furniture on resident health in homes for the elderly and the infirm (the so-called nursing homes). Through analysis and comparison of examples of existing furniture solutions furnished in homes in the Czech Republic and the Republic of Croatia, the requirements and criteria on the quality of furniture for resident health were defined. The aim of the survey methods and interviews was to determine the level of resident satisfaction, and methods of observation and photography were used to confirm the quality of design and construction solutions of existing furniture in these facilities in both countries.

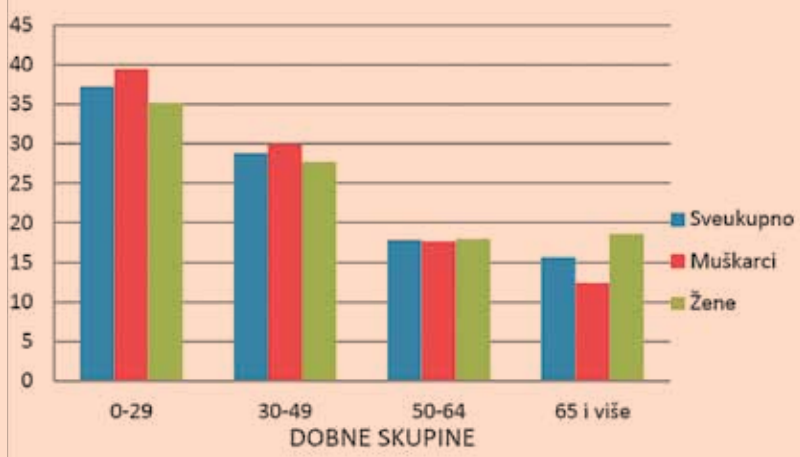

Udio ljudi starijih od 65 godina u odnosu na ukupno pučanstvo po dobi i spolu u Hrvatskoj 2001. (Izvor: DZZS i CZG ZZJZGZ)



Lana Jarža

Razvoj drvene radne stolice

Development of wooden work chair

Vrsta rada: Diplomski rad

Autor: Lana Jarža

Mentor: Izv. prof. dr. sc. Silvana Prekrat

Naslov: Razvoj drvene radne stolice

U ovome radu opisan je proces razvoja proizvoda na primjeru drvene radne stolice. Konstrukcijsko rješenje predviđa korištenje postojećim tehnologijama baziranim uglavnom na glodanju. Masa radne stolice izrađene iz hrastovine iznosi 4,39 kg, a iz jelovine 2,61 kg. Za hrvatske komercijalne vrste drva varira između navedenih izračunatih vrijednosti, što je pogodno za prenošenje radne stolice. Postignuta je konstrukcijska složenost 0,5, koja prema klasifikaciji pripada srednjemu razredu složenosti proizvoda. Postojeće stolice na tržištu uglavnom su veće konstrukcijske složenosti, Zbog maloga udjela materijala i maloga broja različitih dijelova proizvod je pogodan za izradu iz voćkarica, koje proizvod mogu prezentirati visokom vrijednošću.

Na uzorku od 102 studenta utvrđena najniža visina stolice iznosi 37 cm, a najviša 52 cm, pri čemu visina sjedala za izmjerenu populaciju iznosi 45,1 cm.

Novoosmišljeni dodatni elementi zaštitnih kapica omogućuju stvaranje dodatne vrijednosti proizvoda, a izmjenom elemenata naslona, nožišta i zaštitnih kapica moguće je proizvesti proizvode različitih cjenovnih razreda te stvoriti asortiman proizvoda. Izmjenjivi umetci (zaštitne kapice) izrađeni su aditivnim postupkom 3D tiska te su inovacija.

Type of work: Master's Thesis

Author: Lana Jarža

Mentor: Silvana Prekrat, PhD, Associate professor

Title: Development of wooden work chair

The thesis describes the process of product development, using the example of wooden work chairs. The construction solution envisages the use of existing technologies based primarily on milling. The mass of the work chair built of oak is 4.39 kg, as compared to the fir chair weighing 2.61 kg. For the commercial Croatian wood types, this varies between the two stated values, which is suitable for moving work chairs. Construction complexity of 0.5 was achieved, which according to the classification belongs to the class of products of moderate complexity. The existing chairs in the market primarily have greater construction complexity. Due to the small share of materials and small number of different parts, the product is suitable for production from fruit wood, which could present a high value product.

In a sample of 102 students, it was established that the lowest height of the chair was 37 cm, and the highest 52 cm, in which the height of the seat for this sample population was 45.1 cm. The newly conceived additional element of protective caps creates added value of the product, and changes to the elements such as back, legs and protective caps makes it possible to produce the chair in different price ranges and to create a product line. Exchangeable inserts (protective caps) were created using the additive procedure in 3D printing and represent an innovation.

Margareta Kovačević

Oblikovanje suvremenog namještaja temeljenog na tradiciji i baštini
Design of contemporary furniture based on tradition and heritage

Vrsta rada: Diplomski rad

Autor: Margareta Kovačević

Mentor: Doc. dr. sc. Danijela Domljan

Naslov: Oblikovanje suvremenog namještaja temeljenog na tradiciji i baštini

U radu je prikazana i objašnjena povezanost tradicije i baštine s oblikovanjem suvremenoga namještaja. Tradicija i baština dio su kulturnoga nasljeđa koje su ostavile prethodne generacije radi toga da se desetljećima stvarana tradicija čuva i dalje prenosi s naraštaja na naraštaj. Promatrajući suvremeni način života sve se više teži autentičnosti i praktičnosti tradicionalnoga namještaja, koji je prije svega bio stvaran da služi svrsi.

Istraživanjem i analizom postojećih rješenja te uspoređivanjem hrvatskoga i slovenskoga kulturnog nasljeđa, objašnjeno je kako tradicija i baština mogu znatno utjecati na oblikovanje funkcionalnoga suvremenog namještaja. Rezultat je razvoj suvremenoga programa namještaja za blagovanje koji inspiraciju pronalaze u baštini Republike Hrvatske te tradicionalnim funkcionalnim i estetskim elementima koji su se nekoć upotrebljavali.

Type of work: Master's Thesis

Author: Margareta Kovačević

Mentor: Danijela Domljan, PhD, Assistant Professor

Title: Design of contemporary furniture based on tradition and heritage

The study presented and explained the connections between tradition and heritage in the design of contemporary furniture. Tradition and heritage are part of the cultural legacy. Previous generations have left them with the aim for the created tradition to be kept for decades, passed on further from generation to generation. In view of the modern lifestyle, there is a tendency for authenticity and practicality of traditional furniture, primarily intended to be practical and useful.

The study and analysis of the existing situations, and a comparison of the Croatian and Slovenian cultural heritage, explains how tradition and heritage can significantly affect the creation of functional modern furniture. The result is a development of contemporary dining furniture that finds its inspiration in the Croatian heritage and traditional functional and aesthetic elements once used.



Ana Mišetić

Postojanost poliuretanskog laka iz utekućenog drva pri ubrzanom izlaganju ultraljubičastom zračenju

Durability of polyurethane varnish from liquefied wood at accelerated exposure to ultraviolet radiation

Vrsta rada: Diplomski rad

Autor: Ana Mišetić

Mentor: Prof. dr. sc. Vlatka Jirouš-Rajković, prof.dr.sc. Marko Petrič

Naslov: Postojanost poliuretanskog laka iz utekućenog drva pri ubrzanom izlaganju ultraljubičastom zračenju

Intenzivno iscrpljivanje fosilnih izvora sirove nafte i sve veća briga za okoliš utjecali su na brojna istraživanja alternativnih izvora sirovine. Drvo kao dominantan i pristupačan materijal zauzima veliku važnost u globalnoj slici dostupnoga sirovinskog potencijala. Utekućenje drva, najbitnija stavka ovoga rada, relativno je nova termokemijska tehnika čiji je cilj pretvorba drvene biomase u razgradive polimerne materijale i povećanje postotka iskorištenja drva. U posljednjemu desetljeću tako je intenzivno istraživano utekućeno drvo u svojstvu prirodnoga materijala s visokim potencijalom uporabe u različitim primjenama (gorivo, pjene, ljepila, premazi i sl.), a radi zamjene sintetičkih naftnih derivata. Ultraljubičasto zračenje smatra se najodgovornijim za pokretanje fotokemijske razgradnje premaza i drvne površine stvaranjem slobodnih radikala tijekom izlaganja vanjskim okolišnim uvjetima. Predmet ovoga istraživanja bila je formulacija poliuretanskoga laka iz utekućenoga drva bez i s dodanim aditivom za hidrofobizaciju te usporedba njihovih svojstava sa komercijalnim poliuretanskim lakom. Postojanost poliuretanskoga laka iz utekućenoga drva tijekom ubrzanoga izlaganja UV zračenju u Atlas Suntest XXL+ uređaju ispitivala se prateći promjenu boje i sjaja, a zatim i ostalih svojstava: debljine suhoga filma, kontaktnoga kuta kapi, otpornosti površine prema hladnim tekućinama i udarcima tvrdim predmetom te adhezivne čvrstoće premaza (zarezivanje mrežice i otkidanje valjčića). Rezultati mjerenja tijekom i nakon izlaganja pokazali su znatne promjene svojstava za sve premaze, izuzev otpornosti na hladne tekućine koja je jedina ostala nepromijenjena i zadovoljavajuća. Može se reći da se postojanost poliuretanskih lakova iz utekućenoga drva na ubrzano izlaganje UV zračenju pokazala bitno manjom u odnosu na komercijalni poliuretanski lak.



Type of work: Master's Thesis

Author: Ana Mišetić

Mentor: Professor Vlatka Jirouš-Rajković, PhD, Professor Marko Petrič, PhD,

Title: Durability of polyurethane varnish from liquefied wood at accelerated exposure to ultraviolet radiation

Intensified use of fossil sources of crude oil and the ever-growing environmental concern have resulted in numerous studies on the alternative sources of raw materials. Wood as the dominant and most accessible material has great importance in the global raw material availability. Liquefaction of wood, the most important item of this study, represents a relatively new thermochemical technique that aims to convert wood biomass into biodegradable polymeric materials and increase the percentage in wood use. Over the past decade, liquefied wood has been intensively studied as a natural material with high potential in a variety of applications (fuel, foam, adhesives, coating, etc.) with the single objective of replacing synthetic petroleum derivatives. Ultraviolet radiation is considered to be the most effective for initiating the photochemical decomposition of coatings and wood surfaces by creating free radicals during exposure to external environmental conditions. The subject of this study was the formulation of polyurethane varnish from liquefied wood, with and without the addition of additives for hydrophobization and comparisons with polyurethane varnish. Stability of polyurethane from liquefied wood during accelerated exposure to ultraviolet radiation in the Atlas Suntest XXL+ was tested by tracking changes in colour and gloss, in addition to other properties: thickness of dry film, contact angle of drops, surface resistance to cold liquids and blows with hard objects and adhesive strength of coating (grid cuts and roller breaks). The results of measuring during and after the exposure showed significant changes in the properties for all coatings, excluding the resistance to cold liquids, which remained unchanged and satisfactory. Ultimately, it can be concluded that the stability of polyurethane from liquefied wood under accelerated exposure to UV radiation is significantly lower than the stability of commercial polyurethane varnish.

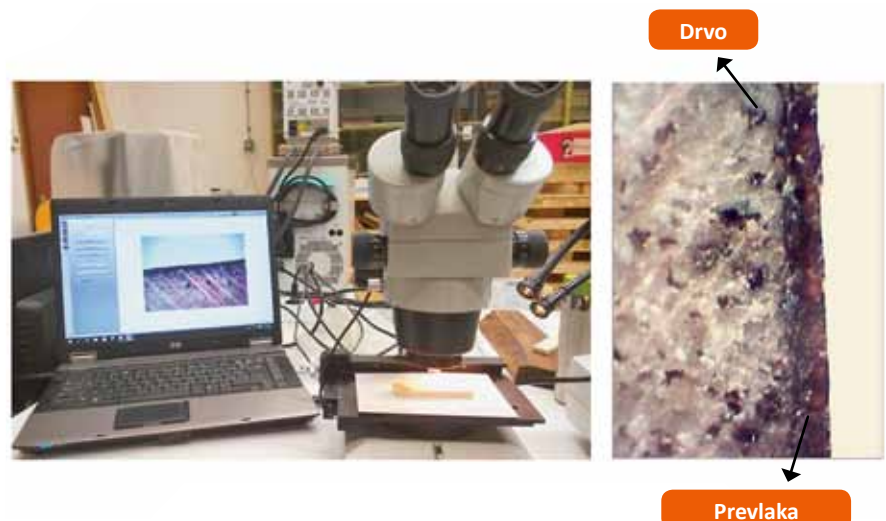

Drvnotehnološki procesi

Wood technology processes

Autor: Jure Beljo

Predmet: Tehnološki procesi površinske obrade drva

Mentor: Professor Vlatka Jirouš Rajković, PhD

Naslov: Utjecaj nanočestica cerijevog (IV)-oksida na postojanost sustava drvopremaz pri izlaganju vanjskim utjecajima

Datum završetka studija: 29. 9. 2016.

Author: Jure Beljo

Subject: Processes of Wood Finishing

Mentor: Professor Vlatka Jirouš Rajković, PhD

Title: The impact of cerium dioxide nanoparticles on wood-coating system during weathering

Date of finished study: 29/09/2016

Autor: Branko Budeš

Predmet: Rukovanje materijalom

Mentor: Prof. dr. sc. Ružica Beljo Lučić

Naslov: Analiza troškova vlastitoga i uslužnog transporta trupaca drvoprerađivačkih tvrtki

Datum završetka studija: 29. 9. 2016.

Author: Branko Budeš

Subject: Material Handling

Mentor: Professor Ružica Beljo Lučić, PhD

Title: Analysis of costs of own and service transport of logs to wood processing companies

Date of finished study: 29/09/2016

Autor: Nikola Kuštro

Predmet: Proizvodni menadžment

Mentor: Prof. dr. sc. Tomislav Grladinović

Naslov: Unapređenje pilanskih kapaciteta na odabranom poslovnom subjektu

Datum završetka studija: 29. 9. 2016.

Author: Nikola Kuštro

Subject: Production management

Mentor: Professor Tomislav Grladinović, PhD

Title: Improvement of sawmill capacity in chose manufacturing

Date of finished study: 29/09/2016

Autor: Marija Novosel

Predmet: Tehnologija ploča od usitnjenog drva

Mentor: Prof. dr. sc. Vladimir Jambrekić

Naslov: Ispitivanje mogućnosti sinteze polimerne osnove biokompozitnih materijala iz drvenih željezničkih pragova povučenih iz uporabe

Datum završetka studija: 29. 9. 2016.

Author: Marija Novosel

Subject: Fragmented Wood Panels Technology

Mentor: Professor Vladimir Jambrekić, PhD

Title: Analysis of possibility of bio composite materials polymeric base synthesis from wooden railroad sleepers withdrawn from use

Date of finished study: 29/09/2016

Autor: Josip Ožegović

Predmet: Zaštita industrijskog okoliša

Mentor: Prof. dr. sc. Anka Ozana Čavlović

Naslov: Analiza pouzdanosti mjerne metode određivanja masene koncentracije lebdećih drvnih čestica

Datum završetka studija: 29. 9. 2016.

Author: Josip Ožegović

Subject: Protection of the industrial environment

Mentor: Professor Anka Ozana Čavlović, PhD

Title: Reliability analysis of measurement method for determination of mass concentration of airborne wood dust

Date of finished study: 29/09/2016

Autor: Krunoslav Đerek
Predmet: Upravljanje i osiguranje kvalitete / Quality assurance and management
Mentor: Doc. dr. sc. Krešimir Greger / Krešimir Greger, PhD, Assistant Professor
Naslov: Analiza sustava upravljanja kvalitetom u proizvodnji namještaja
Datum završetka studija : 23. 9. 2016.
Author: Krunoslav Đerek
Subject: Quality assurance and management
Mentor: Krešimir Greger, PhD, Assistant Professor
Title: Analysis of Quality Management System in Furniture Production
Date of finished study: 23/09/2016

Autor: Ivica Kupinić
Predmet: Pilanska tehnologija drva II
Mentor: Doc. dr. sc. Josip Ištvančić
Naslov: Prilog istraživanju promjene gustoće oblog ogrjevnog drva obične bukve (*Fagus sylvatica L.*) uslijed prirodnog sušenja
Datum završetka studija: 23. 9. 2016.
Author: Ivica Kupinić
Subject: Sawmill technology of wood II
Mentor: Josip Ištvančić, PhD, Assistant Professor
Title: Contribution to study of changes in round-firewood density of European beech (*Fagus sylvatica L.*) due to air drying
Date of finished study: 23/09/2016

Autor: Ivan Matušin
Predmet: Tehnološki procesi površinske obrade drva
Mentor: Prof. dr. sc. Vlatka Jirouš Rajković
Naslov: Svojstva površine drva obrađenog uljima
Datum završetka studija
Author: Ivan Matušin
Subject: Technological process in wood surface processing
Mentor: Professor Vlatka Jirouš Rajković, PhD
Title: Properties of wood surface finished with oils
Date of finished study: 23/09/2016

Autor: Ivan Ravnjak
Predmet: Pilanska tehnologija drva II
Mentor: Doc. dr. sc. Josip Ištvančić
Naslov: Utjecaj kvalitete i načina piljenja trupaca obične bukve (*Fagus sylvatica L.*) na kvantitativno i vrijednosno iskorištenje
Datum završetka studija: 23. 9. 2016.
Author: Ivan Ravnjak
Subject: Sawmill technology of wood II
Mentor: Josip Ištvančić, PhD, Assistant Professor
Title: The impact of quality and sawing method of European beech (*Fagus sylvatica L.*) saw logs on the quantity and value recovery
Date of finished study: 23/09/2016

Autor: Matija Abramović
Predmet: Tehnološki procesi površinske obrade drva
Mentor: Prof. dr. sc. Vlatka Jirouš Rajković
Naslov: Utjecaj nanočestica cerijevog(IV) oksida na svojstva vodenih poliakrilatnih lazura za drvo
Datum završetka studija: 23. 9. 2016.
Author: Matija Abramović
Subject: Technological processes of wood surface finishing
Mentor: Professor Vlatka Jirouš Rajković, PhD
Title: The impact of cerium dioxide nanoparticles on properties of polyacrylate exterior wood stains
Date of finished study: 23/09/2016

Autor: Juraj Aničić
Predmet: Pilanska tehnologija drva II
Mentor: Doc. dr. sc. Josip Ištvančić
Naslov: Prilog istraživanju promjene gustoće prefabriciranog cijepanog ogrjevnog drva obične bukve (*Fagus sylvatica L.*) uslijed prirodnog sušenja
Datum završetka studija: 23. 9. 2016.

Author: Juraj Aničić

Predmet: Sawmilling Technology 2

Mentor: Josip Ištvančić, PhD, Assistant Professor

Title: Contribution to study of changes in prefabricated-split firewood density of European beech (*Fagus sylvatica* L.) due to air drying

Date of finished study: 23/09/2016

Autor: Marko Šaško

Predmet: Tehnološki procesi površinske obrade drva

Mentor: Prof. dr. sc. Vlatka Jirouš Rajković

Naslov: Utjecaj brušenja na adheziju i sjaj poliuretanskog laka na drvu

Datum završetka studija: 9. 9. 2016.

Author: Marko Šaško

Subject: Processes of Wood Finishing

Mentor: Professor Vlatka Jirouš Rajković, PhD

Title: The impact of sanding on adhesion and gloss of polyurethane coating on wood

Date of finished study: 09/09/2016

Autor: Josip Bakija

Predmet: Tehnologija drvnih proizvoda za graditeljstvo

Mentor: Doc. dr. sc. Vjekoslav Živković

Naslov: Obilježja drvene gradnje turističkih objekata u Dalmaciji

Datum završetka studija: 29. 9. 2016.

Author: Josip Bakija

Subject: Technology of Wood Building Components

Mentor: Vjekoslav Živković, PhD, Assistant Professor

Title: Characteristics of tourist wood buildings in Dalmatia

Date of finished study: 29/09/2016

Autor: Krešimir Balaško

Predmet: Tehnologija drvnih proizvoda za graditeljstvo

Mentor: Prof. dr. sc. Hrvoje Turkulin

Naslov: Dimenzijska i oblikovna stabilnost drvenih podnih elemenata

Datum završetka studija: 29/09/2016

Author: Krešimir Balaško

Subject: Technology of Wood Building Components

Mentor: Professor Hrvoje Turkulin, PhD

Title: Dimensional and shape stability of wooden flooring elements

Date of finished study: 29/09/2016

Juraj Aničić

Prilog istraživanju promjene gustoće prefabriciranog cijepanog ogrjevnog drva obične bukve (*Fagus sylvatica L.*) uslijed prirodnog sušenja

Contribution to study of changes in prefabricated-split firewood density of European beech (*Fagus sylvatica L.*) due to air drying

Vrsta rada: Diplomski rad

Autor: Juraj Aničić

Mentor: Doc. dr. sc. Josip Ištvančić

Naslov: Prilog istraživanju promjene gustoće prefabriciranog cijepanog ogrjevnog drva obične bukve (*Fagus sylvatica L.*) uslijed prirodnog sušenja

U radu su eksperimentalno i teorijski istraženi utjecaji parametara vlage, mase, volumena i gustoće prefabriciranih cjepanica ogrjevnoga drva zbog velike važnosti za komercijalno poslovanje takvim drvom. Istraživanje je provedeno na uzorku od 209 komada cjepanica. Cjepanice su izrađene u jednome specijaliziranom proizvodnom pogonu mehaniziranom tehnologijom uz upotrebu motorne lančane pile, tračnih pila i hidrauličkih cjepača. Svaka je cjepanica za potrebe istraživanja izmjerena i obilježena pločicom, te je na njima provedeno mjerenje mase, dimenzija i vlage u sirovome i prosušenome stanju. Prirodno sušenje izvedeno je na zaklonjenome i dobro provjetrenome dijelu stovarišta cijepanoga ogrjevnog drva. Sušenje je cjepanica trajalo u vremenskome razdoblju od 28. 3. 2015. do 3. 10. 2015., odnosno ukupno 196 dana.

Prosječan sadržaj vode u cjepanicama prije sušenja iznosio je 66,02 %. U prosušenome stanju, prosječan sadržaj vode u cjepanicama iznosio je 15,74 %. Prosječna vrijednost mase cjepanica s obzirom na sve izmjerene cjepanice u sirovome stanju iznosila je 1,69 kg, a u prosušenome je stanju vrijednost je smanjena na 1,19 kg. Gledano s obzirom na sirovo stanje, gubitak u masi iznosio je prosječno 29,5 %. U sirovome stanju aritmetička sredina volumena svih cjepanica iznosila je 0,00171 m³, dok je u prosušenome iznosila 0,00148 m³. Gledano s obzirom na sirovo stanje, smanjenje volumena iznosilo je prosječno 13,4 %. Aritmetička sredina za gustoću cjepanica u sirovome stanju iznosila je 988,71 kg/m³, a za prosušeno stanje iznosila je 806,76 kg/m³. Gledano s obzirom na sirovo stanje, smanjenje gustoće iznosilo je prosječno 18,2 %.





Type of work: Master's Thesis

Author: Juraj Aničić

Mentor: Josip Ištvančić, PhD, Assistant Professor

Title: Contribution to study of changes in prefabricated-split firewood density of European beech (*Fagus sylvatica L.*) due to air drying

This study explored the experimental and theoretical parameters of moisture, mass, volume and density of prefabricated split firewood logs, due to the great importance of the commercial trading of such wood. The study examined 209 samples of split firewood logs. Split firewood logs were made in a specialized factory with mechanized technology. The tools and machines used were chainsaws, bandsaws and hydraulic log splitters. For purpose of the research each firewood log was measured and marked with the measurement of mass, dimensions and moisture in raw and dryish condition in a storage of split firewood. Air drying was conducted in a windy and sheltered area and took 196 days, from 2nd March to 3rd October 2015.

The average moisture of firewood before drying was 66.02%. In dryish condition, the average moisture of firewood was 15.74%. The average mass of firewood in raw condition was 1.69 kg, while in the dryish condition, the average mass was reduced to 1.19 kg. The loss of mass was 29.5%. In raw condition, the average volume of firewood was 0.00171 m³, while in the dryish condition, it was 0.00148 m³. In comparison to the raw condition, the average value was 13.4%. The average density of firewood logs in raw condition was 988.71 kg/m³, and in dryish condition was 806.76 kg/m³. In comparison to the raw condition, the density was reduced by 18.2%.



Josip Bakija

Obilježja drvene gradnje turističkih objekata u Dalmaciji
Characteristics of tourist wood buildings in Dalmatia

Vrsta rada: Diplomski rad

Autor: Josip Bakija

Mentor: Doc. dr. sc. Vjekoslav Živković

Naslov: Obilježja drvene gradnje turističkih objekata u Dalmaciji

Diplomski rad donosi pregled problematike gradnje drvenih kuća za turističke svrhe u obalnome pojasu: obilježja klime u Dalmaciji, obilježja i prednosti gradnje drvom te načini održavanja drvenih kuća u promatranim uvjetima. Rad sadržava i detaljnu analizu triju primjernih objekata smještena u kampovima u srednjoj Dalmaciji. Analiza podrazumijeva pregled načina gradnje, izbor materijala, stanje objekata po pitanju fizičke i konstrukcijske zaštite, površinske obrade te preporuke za obnovu i održavanje.

Obilježja su drvene gradnje u priobalnome području povezana ponajprije s namjenom objekata. Kućicama koje se grade uz more se koriste gotovo isključivo tijekom toploga dijela godine kada nije potrebno dodatno grijanje i kada se veći dio vremena provodi izvan objekta na terasi. Stoga se važnost pridaje velikim prozorima i velikim vratima, po mogućnosti i kliznim stijenama. Velika ulazna vrata omogućuju tzv. open-space koncept prostora. Analizom gore opisana triju kampova može se zaključiti da se pri planiranju i gradnji vodilo nedovoljno računa o mjerama fizičke i konstrukcijske zaštite. Dodatna bi edukacija vlasnika o potrebi pravovremena održavanja drvene građe s jedne strane rezultirala atraktivnijim izgledom objekata, a s druge nižim troškovima održavanja.

Type of work: Master's Thesis

Author: Josip Bakija

Mentor: Vjekoslav Živković, PhD, Assistant Professor

Title: Characteristics of tourist wood buildings in Dalmatia

This thesis provides an overview of the issues of constructing wood houses for tourism purposes in coastal areas: characteristics of the climate in Dalmatia, features and advantages of wood construction and methods of maintenance of wood houses in the observed conditions. The study contains a detailed analysis of three sample objects located in camping sites in central Dalmatia. The analysis includes a review of the construction method, material selection, state of facilities in terms of physical and structural protection, surface treatment and recommendations for restoration and maintenance.

Characteristics of wood buildings in the coastal area are primarily related to their purpose. Houses are almost exclusively used during the warm period of the year when no additional heating is required, and when their users spend most of their time on the outdoor terrace. Therefore, importance is given to large windows and doors, possibly sliding doors, which enable an open-space concept. Based on the analysis of these structures, it can be concluded that insufficient attention was paid to the measures of physical and structural protection during the planning and construction stages. Additional education of owners about the need for regular maintenance of timber parts would result in a more attractive appearance of the structures, and lower maintenance costs.



Krešimir Balaško

Dimenzijska i oblikovna stabilnost drvenih podnih elemenata:
dopuna metodike HRN EN 1910 ispitivanjem podnih ploha

**Dimensional and Shape Stability of Wooden Flooring Elements:
Methodological extension of HRN EN 1910 to Testing of Flooring Panels**

Vrsta rada: Diplomski rad

Autor: Balaško Krešimir

Mentor: Prof. dr. sc. Turkulin Hrvoje

Naslov: Dimenzijska i oblikovna stabilnost drvenih podnih elemenata:
dopuna metodike HRN EN 1910 ispitivanjem podnih ploha

U diplomskome radu istražena je i utvrđena dimenzijska i oblikovna stabilnost osam različitih vrsta drvenih podnih obloga. Ispitivanje prema normi HRN EN 1910: 2015 – *Drveni podovi i drvene obloge zidova i stropova – Određivanje stabilnosti dimenzija*, u kojemu se ispituju promjene dimenzija i oblika individualnih podnih elemenata pri promjenama uvjeta vrlo vlažne i suhe klime, prošireno je ispitivanjem elemenata u podnim ploham da bi se ustanovila podobnost metode po HRN EN 1910 da odrazi realno ponašanje drvenih podova u uporabi.

Osim postupaka propisanih normom (apsolutne i relativne promjene dimenzija i deformacija), utvrđeno je i novouvedeno svojstvo gipkosti – povratnost dimenzija i oblika u početno stanje.

Predložena je razredba podova prema postojanosti pri klimatskim opterećenjima koja se javljaju, primjerice, u vlažnim prostorima, prostorima koji se često čiste vodom ili na podnome grijanju.

Iskazivanje gipkosti bitno doprinosi mogućnosti razredbe drvenih podnih elemenata s obzirom na trajnost zadržane deformacije nakon izmjene klimatskih djelovanja. Neočekivano velikom se pokazala krutost masivnoga lakiranog parketa, koji trajno zadržava najveće promjene u širinu, uz dvoslojni na HDF ploči. Troslojni su parketi imali male promjene (kolebanja) i zadržali su malenu trajnu deformaciju te su se uz laminatni pod pokazali najboljim proizvodom. Novouvedenom metodikom izlaganja ploha postiže se bolji uvid u realna fizikalna svojstva proizvoda.

Definirali smo novi pojam stabilnosti dimenzija proizvoda, u pojam *kombinirane dimenzijske stabilnosti* dcr_{comb} , kako bi se mogli uspoređivati masivni drveni podni elementi (koji bubre i utežu poglavito po širini) s višeslojnima, kod kojih je promjena duljine moguće vrlo izražena. Razredba svih proizvoda (slika 3) daje logične odnose među proizvodima različitih tehničkih karakteristika. Proizvodi se razlučuju u ekstremne kategorije: nestabilne (masivni parketi i oni na ploči HDF-a), vrlo stabilne proizvode (troslojni parket i laminatni pod); nelakirani parket je nestabilniji od lakiranoga, dvoslojni na četinjačama je nestabilniji od dvoslojnoga na furnirskoj ploči.

Završna razredba u odabranim kategorijama dimenzijske stabilnosti – širine i duljine te oblikovne stabilnosti - koritavosti i izvijenosti - predstavlja vrlo indikativne ocjene o ponašanju pojedinih podnih proizvoda tijekom svih ciklusa klimatiziranja. Razredba će omogućiti prijedlog dodatka normi HRN EN 1910.

Uvođenjem svojstva gipkosti pokazano je da se proizvodi mogu logično razvrstati u stabilne i gipke (najbolje), stabilne i krute, nestabilne i gipke te nestabilne i krute (najnepovoljnije) podne proizvode.

Predloženo metodičko poboljšanje norme HRN EN 1910 izlaganjem podnih elemenata u slogovima (podnim ploham) pokazalo se opravdanim jer osigurava bolju bliskost sustava izlaganja sa simuliranim uvjetima u uporabi. Predložiti će se aneks norme.



Type of work: Master's Thesis

Author: Balaško Krešimir

Mentor: Turkulin Hrvoje, PhD, Professor

Title: Dimensional and Shape Stability of Wooden Flooring Elements:
Methodological extension of HRN EN 1910 to Testing of Flooring Panels

This dissertation examined and established the dimensional and form stability of eight types of wooden floor coverings. Testing was conducted according to the standard HRN EN 1910: 2015 – Wooden floors and wooden wall and ceiling panels – Determining dimension stability, in which changes to the dimensions and forms of individual floor elements were tested under changes in environmental conditions in very humid and dry climates. The testing of elements in floor surfaces was expanded to determine the suitability of methods by HRN EN 1910 to reflect the realistic behaviour of wooden floors in use.

In addition to the procedures listed in the standard (absolute and relative changes in dimension and deformations), the newly introduced property flexibility was added – as the ability of the material to regain its original dimension and form.

Proposed was the classification of floors for their durability under climatic loads that appear, for example, in humid rooms, rooms that are frequently cleaned with water, or subjected to floor heating.

The expression of flexibility significantly contributes to the possibility of classification of wooden floor elements regarding the durability of deformations following changes in climatic conditions. An unexpectedly high rigidity of mass was found in lacquered parquet, which permanently retained the largest changes in width, with two-ply HDF lacquer on panels. Three-layer parquets had small changes (variations) and retained a small permanent deformation, and together with the laminate floors proved to be the best product. The newly introduced method of testing panels achieved a better overview of the actual physical properties of the products.

A new concept of the stability of product dimensions was defined, in the concept combined dimension stability *dcrcomb*, in order to compare massive wood floor elements (that swell and expand primarily in width) with multi-layer elements, in which changes in length were strongly pronounced. The classification of all products (Figure 3) gives the logical relationships between products with varying technical characteristics. Products are differentiated in extreme categories: unstable (full parquets and those on HDF panels), very stable products (three-layer parquet and laminate floors); unlacquered parquet is less stable than lacquered, two-layer on conifers is less stable than two-layer on veneer.

The final classification into the selected categories of dimensional stability - width and length and form stability – warping and bending represents a highly indicative assessment of the behaviour of individual floor products during all climate control cycles. The classification will enable a proposal for amendments to the standard HRN EN 1910.

With the introduction of the flexibility property, it was shown that products can be logically classified into stable and flexible (best), stable and rigid, unstable and flexible and unstable and rigid (least favourable). The proposed method improves the standard HRN EN 1910 as subjecting floor elements in sections (floor surfaces) has proven to be justified as it better approximates the exposure system with the simulated conditions in use. An annex to the standard will be proposed.

**Dimenzijska i oblikovna stabilnost
drvenih podnih elemenata:**
dopuna metodike HRN EN 1910 i spitivanjem podnih ploha

**Dimensional and Shape Stability
of Wooden Flooring Elements:**
Methodological extension of HRN EN 1910
to Testing of Flooring Panels

PROIZVOD PRODUCT	ŠIRINA WIDTH		DULJINA LENGTH	
	STABILNOST STABILITY	GIPKOST FLEXIBILITY	STABILNOST STABILITY	GIPKOST FLEXIBILITY
2L PLY	≈	≈	●	●
2L HDF	≈	●	●	●
2L SW	≈	≈	≈	≈
PQ M	●	≈	○	○
PQ MV	●	●	○	○
3L M	●	●	≈	≈
3L SW	○	≈	○	≈
LAM	○	≈	○	≈

Legenda:

- – povoljno svojstvo
- ≈ – umjereno povoljno svojstvo
- – nepovoljno svojstvo

PQ OAK M - MASIVNI PARKET HRASTA

PQ OAK L - MASIVNI PARKET HRASTA, LAKIRAN

2L HDF - DVOSLOJNI PARKET NA OSNOVI OD TVRDE VLAKNATICE

2L SW - DVOSLOJNI PARKET NA OSNOVI OD ČETINJAČA

2L PLY - DVOSLOJNI PARKET NA OSNOVI OD FURNIRSKE PLOČE

3L SW - TROSLOJNI PARKET SA SREDNJIČOM OD ČETINJAČA

3L M - TROSLOJNI MASIVNI HRASTOV PARKET

LAM - LAMINATNI POD

KORITAVOST WARPING		IZVIJENOST BENDING	
STABILNOST STABILITY	GIPKOST FLEXIBILITY	STABILNOST STABILITY	GIPKOST FLEXIBILITY
●	≈	●	●
●	●	●	●
○	≈	●	≈
○	○	○	○
≈	○	○	●
●	≈	○	≈
≈	○	○	≈
○	○	○	≈

Legend:

- – favourable properties
- ≈ – moderately favourable properties
- – unfavourable properties

PQ OAK M – FULL OAK PARQUET

PQ OAK L – FULL OAK PARQUET, LACQUERED

2L HDF – TWO -LAYER PARQUET ON HARD FIBERBOARD BASE

2L SW – TWO -LAYER PARQUET ON SOFTWOOD BASE

2L PLY – TWO-LAYER PARQUET ON VENEER BASE

3L SW – THREE-LAYER PARQUET WITH MIDDLE LAYER MADE FROM SOFTWOOD

3L M – THREE-LAYER FULL OAK PARQUET

LAM – LAMINATE FLOORING

Ivica Kupinić

Prilog istraživanju promjene gustoće oblog ogrjevnog drva obične bukve (*Fagus sylvatica* L.) uslijed prirodnog sušenja

Contribution to study of changes in round-firewood density of European beech (*Fagus sylvatica* L.) due to air drying

Vrsta rada: Diplomski rad

Autor: Ivica Kupinić

Mentor: Doc. dr. sc. Josip Ištvančić

Naslov: Prilog istraživanju promjene gustoće oblog ogrjevnog drva obične bukve (*Fagus sylvatica* L.) uslijed prirodnog sušenja

U radu su eksperimentalno i teorijski istraženi utjecaji parametara vlage, mase, volumena i gustoće obloga ogrjevnog drva. Istraživanje je provedeno na uzorku od 17 komada oblica. Oblice su izrađene u jednome specijaliziranom proizvodnom pogonu uz uporabu motorne lančane pile. Svaka je oblica za potrebe istraživanja izmjerena i obilježena pločicom, te je na njima provedeno mjerenje mase, dimenzija i vlage u sirovome i prosušenome stanju. Prirodno sušenje izvedeno je na dobro provjetrenome dijelu stovarišta obloga ogrjevnog drva. Sušenje oblica trajalo je u vremenske razdoblju od 20. 3. 2015. do 12. 10. 2015., odnosno ukupno 207 dana. Prosječan sadržaj vode u oblicama prije sušenja iznosio je 66,02 %. U prosušenome stanju, prosječan sadržaj vode u oblicama iznosio je 32,72 %. Prosječna vrijednost mase oblica u sirovome stanju iznosila je 26,3765 kg, a u prosušenome je stanju ta vrijednost smanjena na 19,2176 kg. Gledano s obzirom na sirovo stanje, gubitak u masi prosječno je iznosio 27,04 %. U sirovome stanju prosječna je vrijednost volumena oblica čiji je volumen određen volumetrijskom metodom iznosila 0,02601 m³, a u prosušenome stanju 0,02346 m³. Kod određivanja volumena Huberovim izrazom prosječna vrijednost u sirovome stanju iznosila je 0,02471 m³, a u prosušenome stanju 0,02316 m³. Gledano s obzirom na sirovo stanje, smanjenje volumena određenoga volumetrijskom metodom prosječno je iznosilo 9,54 %, dok je smanjenje volumena određenoga Huberovim izrazom prosječno iznosilo 6,59 %. Prosječna vrijednost gustoće oblica u sirovome stanju čiji je volumen određen volumetrijskom metodom iznosila je 1022,16 kg/m³, a u prosušenome stanju 823,70 kg/m³. Kod gustoće čiji je volumen određen Huberovim izrazom prosječna vrijednost u sirovome stanju iznosila je 1081,16 kg/m³, a u prosušenome stanju 844,92 kg/m³. Gledano s obzirom na sirovo stanje, smanjenje gustoće čiji je volumen određen volumetrijskom metodom prosječno je iznosilo 19,24 %, dok je smanjenje gustoće čiji je volumen određen Huberovim izrazom prosječno iznosilo 21,85 %.





Type of work: Master's Thesis

Author: Ivica Kupinić

Mentor: Josip Ištvančić, PhD, Assistant Professor

Title: Contribution to study of changes in round-firewood density of European beech (*Fagus sylvatica L.*) due to air drying

This study explored the experimental and theoretical parameters of moisture, mass, volume and density of round firewood. The study was conducted on 17 samples of round firewood, made with chainsaws at a specialized factory. Each firewood piece was measured and marked for the purpose of measuring mass, dimensions and moisture in raw and dryish condition. Air drying was conducted in a windy area and took 207 days, from 20th March to 12th October 2015. The average moisture of firewood before drying was 66.02%. In dryish condition, the average moisture of firewood was 32.72%. The average mass of firewood in raw condition was 26.3765 kg, while in dryish condition the average value was reduced to 19.2176 kg. In comparison to the raw condition, the loss of mass averaged 27.04%. In raw condition, the average volume of firewood, determined by the volumetric method, was 0.02601 m³, and in dryish condition was 0.02346 m³. In determining the volume with the Huber's equation, the average value in the raw condition was 0.02471 m³, and in dryish condition was 0.02316 m³. In comparison to the raw condition, the loss of volume, determined by the volumetric method, averaged 9.54%, while the loss of volume determined with Huber's equation averaged 6.59%. The average density of firewood in raw condition, determined by the volumetric method, was 1022.16 kg/m³, and in dryish condition was 823.70 kg/m³. When determined with Huber's equation, the average density in raw condition was 1081.16 kg/m³, and in dryish condition was 844.92 kg/m³. In comparison to the raw condition, the loss of density determined by the volumetric method averaged 19.24%, while the loss of density determined with Huber's equation averaged 21.85%.



Ivan Matušin

Svojstva površine drva obrađenog uljima

Properties of wood surface finished with oils

Vrsta rada: Diplomski rad

Autor: Ivan Matušin

Mentor: Prof. dr. sc. Vlatka Jirouš-Rajković

Naslov: Svojstva površine drva obrađenog uljima

U ovome su se istraživanju ispitivala svojstva površine drva obrađenoga različitim vrstama ulja. Ulja su premazi koji zbog povećanja ekološke svijesti imaju sve veću primjenu u površinskoj obradi, a ujedno i naglašavaju prirodni izgled drva. U istraživanju su korišteni uzorci hrastovine, bukovine i trešnjevine. Na površinski obrađenim uzorcima ispitano je vrijeme sušenja ulja, žućenje, tvrdoća površine po Brinellu, otpornost prema hladnim tekućinama i toplini, dubina penetracije ulja i boja uljene površine drva.

Type of work: Master's Thesis

Author: Ivan Matušin

Mentor: Professor Vlatka Jirouš-Rajković, PhD

Title: Properties of wood surface finished with oils

This study examined the properties of wood surfaces finished with different types of oil. Oils are coatings that are used more often in surface treatment due to increasing environmental awareness, and oils also emphasize the natural look of wood. Samples of oak, beech and cherry wood were analysed in this study. The drying time of oils, yellowing resistance, Brinell hardness, resistance to cold liquids and heat, penetration depth of oils and colour were measured on oil-treated wood samples.

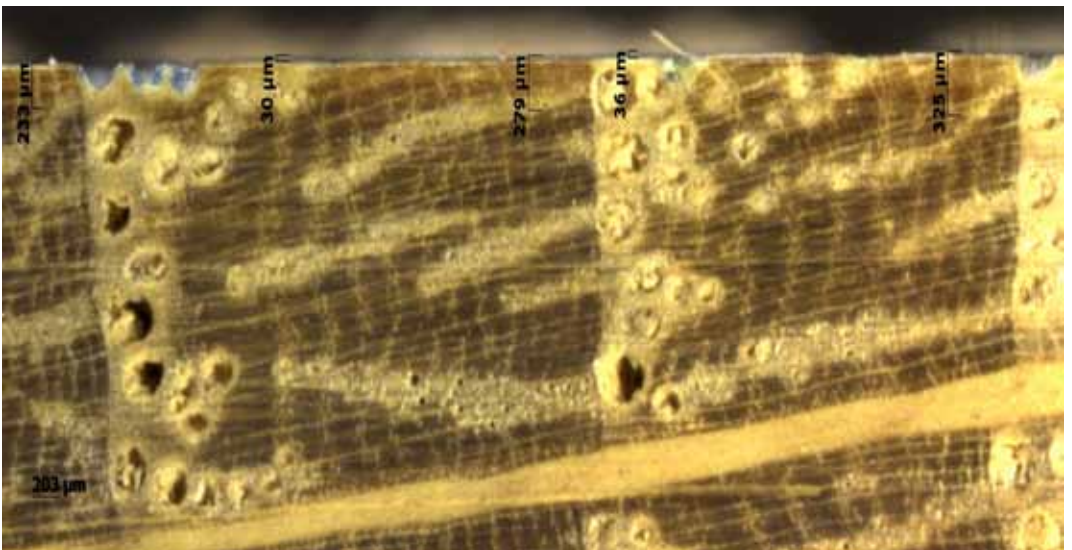
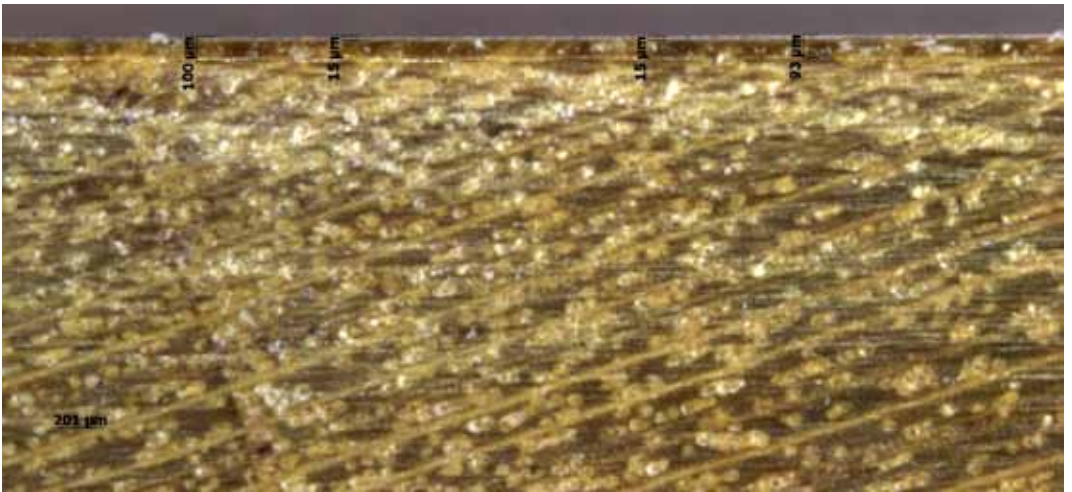
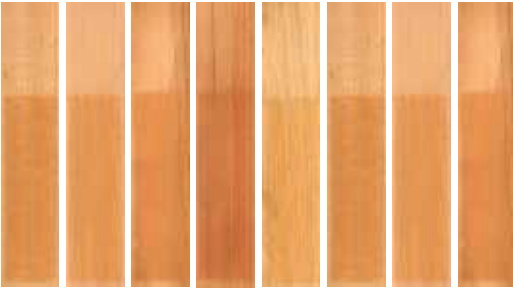

Marija Novosel

Ispitivanje mogućnosti sinteze polimerne osnove biokompozitnih materijala iz drvenih željezničkih pragova povučениh iz uporabe

Analysis of possibility of bio composite materials polymeric base synthesis from wooden railroad sleepers withdrawn from use

Vrsta rada: Diplomski rad

Autor: Marija Novosel

Mentor: Prof. dr. sc. Vladimir Jambreković

Naslov: Ispitivanje mogućnosti sinteze polimerne osnove biokompozitnih materijala iz drvenih željezničkih pragova povučениh iz uporabe

U ovome diplomskom radu ispitala se mogućnost izrade polimerne osnove biokompozitnih materijala iz usitnjenoga drva željezničkih pragova povučениh iz uporabe. Rezultati ispitivanja pokazali su da je moguće proizvesti polimerni materijal iz celuloze iz drva tretiranoga kreozotom, koji je prema svojstvima gotovo identičan onomu pripremljenomu iz netretiranoga drva. No, za acetilaciju drva tretiranoga kreozotom potrebno je više kemikalija ako se želi dobiti proizvod višega stupnja acetilacije, a time i povoljnijih svojstava.

Type of work: Master's Thesis

Author: Marija Novosel

Mentor: Professor Vladimir Jambreković, PhD

Title: Analysis of possibility of bio composite materials polymeric base synthesis from wooden railroad sleepers withdrawn from use

This study examined the possibility of producing polymeric base of bio composite materials from milled wood from railroad sleepers withdrawn from use. The results showed that it is possible to produce polymer material from cellulose isolated from wood treated with creosote, which has properties nearly identical to those prepared from untreated wood. However, if the intent is to obtain a product with a higher degree of acetylation and thereby more favourable properties, more chemicals are necessary.

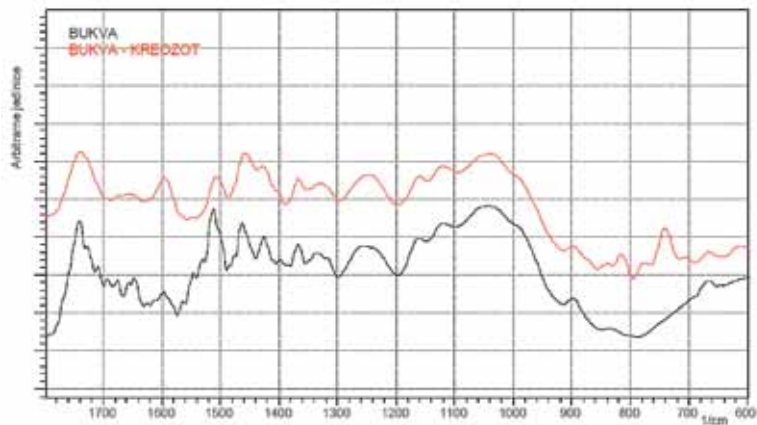

SINTEZA CELULOZNOG ACETATA

a – uzorak celuloze nakon dodatka svih kemikalija

b – dodavanje deionizirane vode

c i d – formiranje strukture i promjena boje celuloznoga acetata

CELLULOSE ACETATE SYNTHESIS

a – cellulose sample after addition of all chemicals

b – addition of deionised water

c and d – formation of structure and colour change of cellulose acetate

Josip Ožegović

Analiza pouzdanosti mjerne metode određivanja masene koncentracije lebdećih drvnih čestica

Reliability analysis of measurement method for determination of mass concentration of airborne wood dust

Vrsta rada: Diplomski rad

Autor: Josip Ožegović

Mentor: Izv. prof. dr. sc. Anka Ozana Čavlović

Naslov: Analiza pouzdanosti mjerne metode određivanja masene koncentracije lebdećih drvnih čestica

Ovim radom analizirane su pouzdanosti dviju različitih vrsta mjerne opreme u postupku sakupljanja lebdećih čestica pri određivanju masene koncentracije drvene prašine koja udisanjem utječe na zdravlje radnika u proizvodnim pogonima i stolarijama. Normom HRN CEN/TR 15230:2005 definirano je trajanje pouzdanoga sakupljanja uzorka (stupanj prikupljanja uzorka t_{minP}) i trajanje sakupljanja za pouzdano vaganje uzorka (stupanj količine uzorka t_{minK}). Cilj je rada odrediti važnost utjecajnih čimbenika (vrsta mjernih uređaja, stvarno vrijeme sakupljanja uzoraka, standardna devijacija vrijednosti mase uzorka, vrijednost masene koncentracije uzorka, vrsta obrade drva) na vrijeme potrebno za pouzdano sakupljanje uzorka i njegovo pouzdano vaganje. Na temelju dosadašnjih određivanih vrijednosti masenih koncentracija ($N = 369$) dobiveni su rezultati pokazali da je sakupljanje lebdećih čestica bilo pouzdanije mjernom opremom B koja je novije proizvodnje od opreme A. Za obje vrste mjerne opreme pouzdanost sakupljanja respirabilne frakcije veća je od pouzdanosti sakupljanja ukupne prašine te je potrebno dulje sakupljati lebdeće čestice ako je zapašenost okolnoga zraka manja.

Type of work: Master's Thesis

Author: Josip Ožegović

Mentor: Anka Ozana Čavlović, PhD, Associate Professor

Title: Reliability analysis of measurement method for determination of mass concentration of airborne wood dust

This study analysed the reliability of two different types of measuring equipment in the process of collecting airborne particles in determination of inhalable wood dust mass concentration, in relation to the risk of workers to hardwood dust in production plants and carpentries exposure. The norm HRN CEN/TR 15230:2005 defines the duration of the collection of wood dust samples (the limit of detection t_{minD}) and the duration of the collection of reliable weighing wood dust sample (limit of quantification t_{minQ}). The aim was to determine the importance of factors on the time required for reliable sample collection and its reliable weighing. The observed influence factors were: type of measuring devices, real-time collection of samples, standard deviation of the sample mass values, the value of the wood sample mass concentration and the type of wood processing. Based on previous collected wood dust samples and their mass concentration values ($N = 369$), the results showed a greater reliability of airborne particle collection by using equipment B, which is of a more recent production of equipment A. For both types of measurement equipment, reliability of the respirable wood dust sample collection was greater than the reliability of total dust collection. Also, collecting airborne particles takes longer if there is less dustiness of the surrounding air.



Uzorkovanje drvene prašine opremom A
Collecting of wood dust samples using equipment A



Uzorkovanje drvene prašine opremom B
Collecting of wood dust samples using equipment B

Ivan Ravnjak

Utjecaj kvalitete i načina piljenja trupaca obične bukve (*Fagus sylvatica* L.) na kvantitativno i vrijednosno iskorištenje

The impact of quality and sawing method of European beech (*Fagus sylvatica* L.) saw logs on the quantity and value recovery

Vrsta rada: Diplomski rad

Autor: Ivan Ravnjak

Mentor: Doc. dr. sc. Josip Ištvančić

Naslov: Utjecaj kvalitete i načina piljenja trupaca obične bukve (*Fagus sylvatica* L.) na kvantitativno i vrijednosno iskorištenje

U radu su eksperimentalno i teorijski istraženi pokazatelji kvantitativnoga i vrijednosnoga iskorištenja trupaca 1., 2. i 3. klase s obzirom na dva načina piljenja, kružno i piljenje u cijelo. Za potrebe svakoga načina piljenja za svaku istraživanu klasu ispiljeno je 5 trupaca, odnosno sveukupno 30 komada. Svaki je trupac za potrebe istraživanja izmjeren i evidentiran prije ulaska u tehnološki proces. Izmjerena mu je duljina i promjer na polovini duljine prema HRN normama. Primarno je piljenje izvedeno na tračnoj pili trupčari. Iz trupaca su piljene piljenice debljine 50 mm. Za prikrajčivanje i okrajčivanje piljenica na zadane mjere koristile su se kružne pile. Svaka je piljenica evidentirana te su izmjerene njezine dimenzije prema HRN normama. Razvrstavanje prema kvaliteti provedeno je prema internome načinu razvrstavanja u A i B klasu.

Kvantitativno iskorištenje pri piljenju kružnim načinom piljenja kretalo se u rasponu od 69,6 do 70,5 % pri izradi neokrajčenih piljenica, odnosno 40,0 do 44,8 % pri izradi okrajčenih piljenica. Kvantitativno iskorištenje pri piljenju načinom piljenja u cijelo kretalo se u rasponu od 77,3 do 81,8 % pri izradi neokrajčenih piljenica, odnosno od 46,0 do 57,9 % pri izradi okrajčenih piljenica. Koeficijent vrijednosnoga iskorištenja pri piljenju kružnim načinom piljenja pri izradi okrajčenih piljenica kretao se u rasponu od 0,2995 do 0,4052. Koeficijent vrijednosnoga iskorištenja pri piljenju načinom piljenja u cijelo pri izradi okrajčenih piljenica kretao se u rasponu od 0,3235 do 0,4469.

Sveukupno gledano porastom kvalitete trupaca raslo je iskorištenje za oba načina piljenja. Gledano s obzirom na način piljenja bolje je iskorištenje postignuto piljenjem u cijelo.

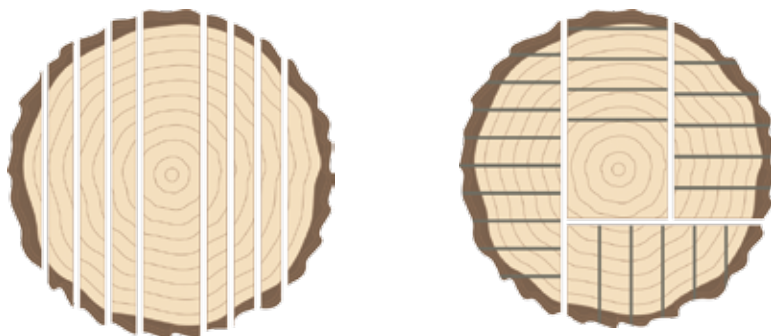

Type of work: Master's Thesis

Author: Ivan Ravnjak

Mentor: Josip Ištvančić, PhD, Assistant Professor

Title: The impact of quality and sawing method of European beech (*Fagus sylvatica L.*) saw logs on quantity and value recovery

The dissertation is an experimental and theoretical study of the quantity and value recovery indicators for logs of classes 1, 2 and 3 with regard to the sawing method: circular and band. For the purposes of each sawing method for each studied class, five logs were sawed, for in total of 30 logs. Prior to the research, each log was measured and recorded prior to entry into the technological process. Length and girth were measured at half the length according to HRN norms. Initial sawing was performed on a band saw. Boards of 50 mm thickness were sawn from the logs. To shorten and edge boards to the given measurements, circular saws were used. Each board was recorded and its dimensions according to the HRN standards measured. Classification by quality was conducted based on the internal standard, into class A and B boards.

The quantitative use in sawing with a circular saw ranged from 69.6 to 70.5% for unedged boards and 40.0 to 44.8% for edged boards. The quantitative use in sawing using the horizontal log band saw ranged from 77.3 to 81.8% for unedged boards, and from 46.0 to 57.9% for edged boards. The coefficient of the usage value in sawing with the circular saw for edged boards ranged from 0.2995 to 0.4052. The coefficient of the usage value for sawing using the horizontal log band saw ranged from 0.3235 to 0.4469.

In general, increased quality of the logs led to an increase in the usage for both sawing methods. In terms of sawing methods, greater efficiency was achieved with the horizontal band saw.



Rektorova nagrada

–

Rector's award

Već niz godina rektor sveučilišta dodjeljuje nagrade za najbolje studentske radove znanstvenoga sadržaja, odnosno umjetnička ostvarenja. Cilj je nagrade poticanje znanstvenoistraživačkoga i umjetničkoga rada te promicanje studentskoga stvaralaštva.

U akademskoj godini 2015./2016. u kategoriji nagrada za individualni znanstveni i umjetnički rad (jedan ili dva autora) u biotehničkome području podijeljeno je ukupno 10 nagrada, od kojih je troje sa Šumarskoga fakulteta. Svečana dodjela Rektorove nagrade održana je 17. lipnja 2016. u kongresnoj dvorani na Ekonomskome fakultetu Sveučilišta u Zagrebu. Studenti Drvnotehnološkoga odsjeka Lana Jarža i Juraj Stanešić bili su dobitnici te prestižne nagrade.

For a number of years, the University Rector has awarded the best student works of the science and arts content. The objective of the award is to stimulate scientific research and artistic work, and to promote student creativity.

In the 2015/2016 academic year, a total of ten awards were granted in the category of individual scientific and artistic work (by one or two students) in the field of biotechnology. Of these, three awards went to the Faculty of Forestry. The official Rector's Award ceremony was held on 17th June 2016 in the Congress Hall of the Faculty of Economics, University of Zagreb. Students of the Wood Technology Section, Lana Jarža and Juraj Stanešić, were winners of this prestigious prize.

Lana Jarža

„LUPA” ormarić za pohranu uzoraka za prepoznavanje anatomskih karakteristika drva
LUPA sample cabinet for the recognition of anatomical properties of wood

Vrsta rada: Rad nagrađen Rektorovom nagradom

Autor: Lana Jarža

Mentor: Izv. prof. dr. sc. Silvana Prekrat

Naslov: „Lupa” ormarić za pohranu uzoraka za prepoznavanje anatomskih karakteristika drva

U ovome radu projektirano je novo rješenje ksiloteke namjenjeno za svakodnevno obrazovanje studenata. Dimenzije ormarića 1060 x 540 x 550 mm omogućuju pohranu 35 uzoraka osnovnih komercijalnih vrsta drva dimenzija 100 x 70 mm koje su dostatne za makroskopsko prepoznavanje i lake za manipulaciju.

Na temelju izmjera 102 studenata utvrđena je minimalna visina studenata 156 cm i maksimalna visina 200 cm. Prosječna visina gledanja pri stajanju iznosi 169,1 cm i prema tome izračunata je prosječna visina postavljanja ručice pri stajanju koja iznosi 111,1 cm. Prema rezultatima određene su gabaritne dimenzije ormarića za uzorke drva.

Mehanizam zupčastoga prijenosa sastoji se od planetarnoga zupčanika pri čemu vanjski promjer prstenastoga zupčanika iznosi 410 mm, a njegove su dimenzije uvjetovane rasponom vidnoga polja studenata i brojem uzoraka. Mehanizam zupčastoga prijenosa zadovoljava funkcionalne, ergonomске i estetske zahtjeve.

Radi preciznije identifikacije atomske građe drva predviđena je lupa na savitljivome stalku s uvećanjem od 2 do 3 puta i bifokalnom lećom te osvjetljenjem.

Odabirom materijala zadovoljeni su estetski, ekonomski i ekološki kriteriji, a drvena konstrukcija ormarića i zupčastoga prijenosa iz brezove furnirske ploče dio je identiteta fakulteta.

Type of work: Student work awarded the Rector's Award

Author: Lana Jarža

Mentor: Silvana Prekrat, PhD, Associate Professor

Title: LUPA sample cabinet for the recognition of anatomical properties of wood

This paper describes the process of developing a new conceptual design for a xylotheque intended for everyday student education. The cabinet dimensions of 1060 x 540 x 550 mm enable the storage of 35 samples of standard commercial types of wood 100 x 70 mm in dimensions which are sufficient for macroscopic identification and are easy for manipulation. Based on measuring of 102 students, a minimum height of students of 156 cm and a maximum height of 200 cm were determined. The average height of view while standing is 169.1 cm at which an average height of placement of handles was calculated to be 111.1 cm. Based on the results, dimensions of the sample cabinet were determined.

The mechanism of the gear transmission consists of the planetary gear at which the outside radius of the ring gear is 410 mm, and its dimensions are conditioned with the range of the viewing field of students and by the number of samples. The mechanism of the gear transmission meets the functional, ergonomic and aesthetic requirements.

For a more precise identification of anatomic structure of wood, a magnifier on a flexible stand is provided with a magnification of between 2 and 3 times and a bifocal lense and light. By the selection of materials, all aesthetic, economical and ecological criteria are met, whereas the wood structure of the cabinet and the wood transmission from the beech.

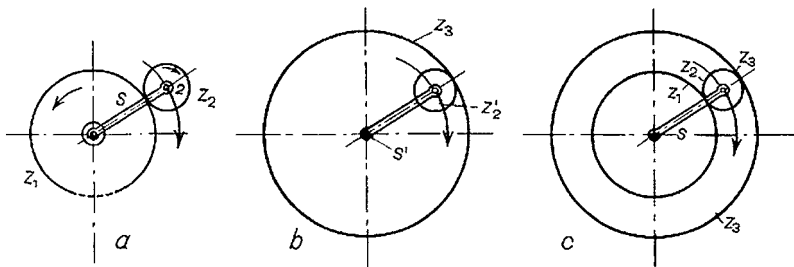
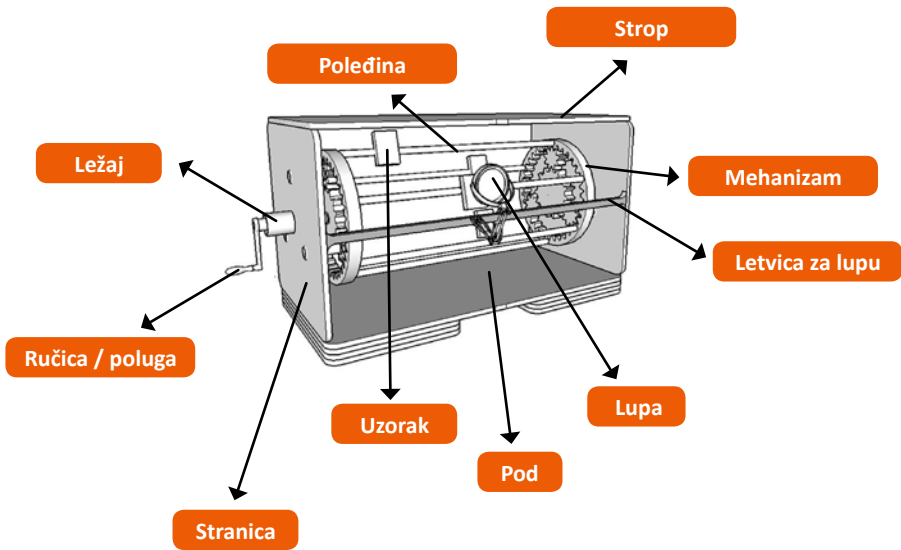

Juraj Stanešić

Utjecaj veličine čestica drva crne topolovine (*Populus nigra* L.) na sadržaj i svojstva bioulja i biougljena

Influence of black poplar wood (*Populus nigra* L.) particle size on the content and properties of bio-oil and bio-charcoal

Vrsta rada: Rad nagrađen Rektorovom nagradom

Autor: Juraj Stanešić

Mentor: Doc. dr. sc. Alan Antonović

Naslov: Utjecaj veličine čestica drva crne topolovine (*populus nigra* L.) na sadržaj i svojstva bioulja i biougljena

U ovome radu istraživana je utjecaj različitih veličina čestica uzoraka drva crne topolovine (*Populus nigra* L.) u postupku spore pirolitičke razgradnje drva na sadržaj i svojstva bioulja i biougljena. Dobiveni rezultati u usporedbi s rezultatima dosadašnjih istraživanja iz literature pokazali su sličnosti pri svim komponentama grupnoga kemijskog sastava drva crne topole, odnosno svi su rezultati u granicama prosječnoga kemijskog sastava za drvo. Svi su rezultati dobivenih produkata iz postupka pirolize iskazani u obliku kvantitativnoga iskorištenja biomase kako bi se dobio jasniji prikaz iskorištenja drva crne topole (*Populus nigra* L.) u vidu bioulja te biougljena. Za što veće kvantitativno iskorištenje ulazne biomase drva crne topole (*Populus nigra* L.) svakako se valja koristiti česticama drva manjima od 0,5 mm u promjeru. pH-vrijednost izuzetno je niska (pH=2) te je potencijalni problem u održavanju skladišnih posuda i cjevovoda za bioulje. Sadržaj suhe tvari relativno je visok, iako je u granicama očekivanih rezultata te time umanjuje količinu dobivenoga tekućeg bioulja. Drvo crne topole samo je jedna od mnogih vrsti drva u nizu koje pokazuju vrlo dobre rezultate u količini, ali i kvaliteti proizvoda procesa pirolize te je kao takvo važna sirovina za pridobivanje bioulja i biougljena. Uz svoje kratko vrijeme obnavljanja sirovine i uz svoj godišnji prirast, drvo crne topole isplativo je rabiti za proizvodnju bioulja i biougljena.

Type of work: Student scientific work awarded with Rector's Award

Author: Juraj Stanešić

Mentor: Alan Antonović, PhD, Assistant Professor

Title: Influence of black poplar wood (*populus nigra* L.) particle size on the content and properties of bio-oil and bio-charcoal

This study examines the effects of different particle size samples of black poplar (*Populus nigra* L.) wood in the slow pyrolytic decomposition on the content and properties of bio-oil and bio-charcoal. The results are compared with previous studies and showed similarities in all components of the chemical composition of black poplar wood. All the results were within the limits of the average chemical composition of wood. All results of the obtained products from the pyrolysis process are expressed in the form of a quantitative yield to give a realistic image of black poplar (*Populus nigra* L.) wood yields in the form of bio-oil and bio-carbon. The conclusion of the study is that particles should be less than 0.5 mm in diameter for the largest quantity yield input of black poplar (*Populus nigra* L.) biomass. The pH value is extremely low (pH = 2), indicating a potential issue in maintaining storage containers and pipelines for bio-oil. The dry matter content is relatively high, although within the expected range, thereby reducing the amount of the obtained liquid bio-oil. Black poplar is only one of the many types of wood to show very good results not only in quantity, but also in the quality of pyrolysis process products. As such, it represents a significant feedstock for the production of bio-oil and bio-coal. With its short time of recovery feedstock and with its annual growth rate, black poplar wood is profitable for use in the production of bio-oil and bio-char.

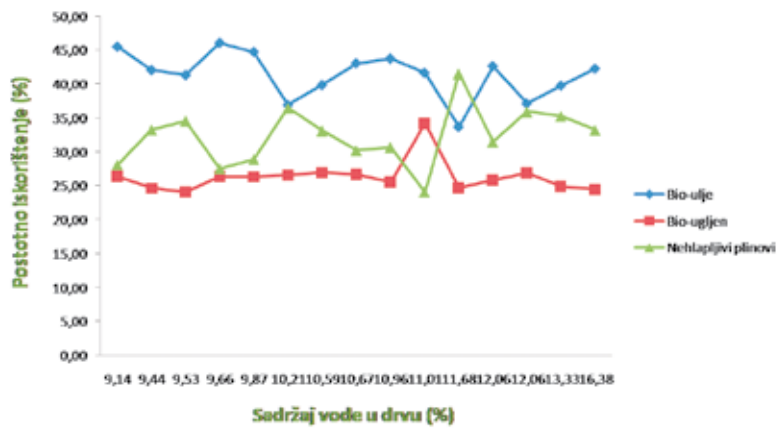
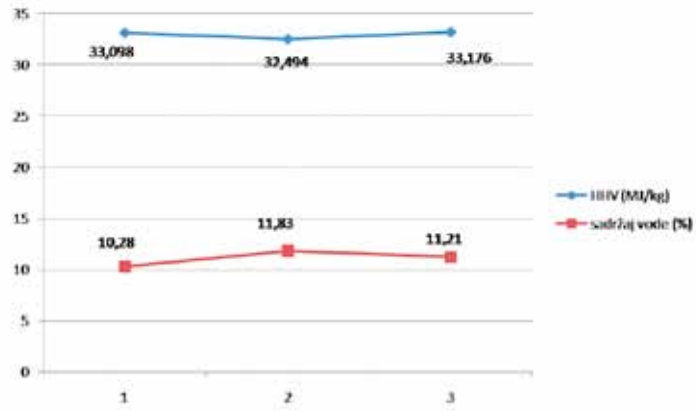
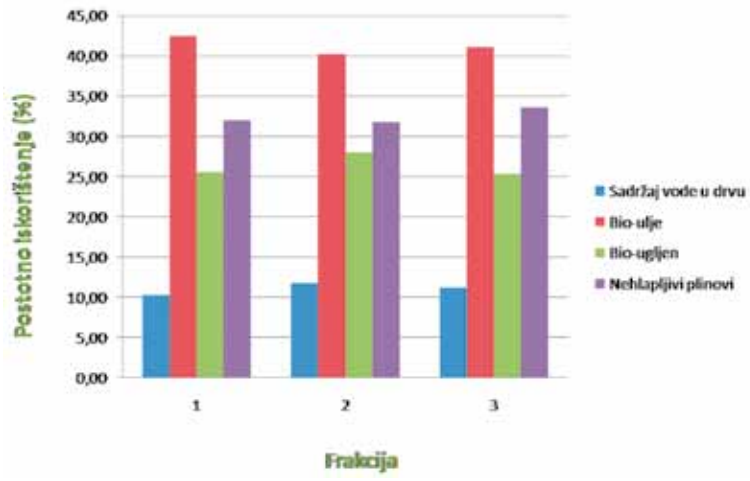

Seminarski radovi

–

Seminar papers

U procesu provođenja nastave radi savladavanja i provjere usvojenoga znanja mogući su razni oblici, a jedan od njih je i samostalna ili timska izrada seminarskih radova koje studenti javno prezentiraju obrađujući zadanu temu. Seminari također mogu biti izvedeni u obliku projekta sa zadatkom iznalaženja novih oblikovnih rješenja ili razvoja proizvoda s detaljnom razradom proizvodne dokumentacije. Seminari su ujedno dobra priprema za buduću izradu diplomskih radova. Javnim predstavljanjem studenti razvijaju komunikacijske i prezentacijske vještine potrebne u budućem radu.

In the process of lecturing, numerous options are available to verify the level of knowledge and mastery of the course materials. One method is the independent or group seminar paper on a given topic, which students then present before the class. Seminars may also be in the form of a term project, aimed at finding new form solutions or product documentation development, with detailing of the production documentation. Seminars are also good preparation for the drafting future dissertations. Through public presentations, students develop communications and presentation skills required in their future work.

Lovro Belina

Virtualna i proširena stvarnost u procesu oblikovanja prostora
Virtual and augmented reality in the spatial design process

Vrsta rada: Seminar na predmetu Konstrukcije proizvoda od drva 4

Autor: Lovro Belina

Mentor: Izv. prof. dr. sc. Silvana Prekrat

Naslov: Virtualna i proširena stvarnost u procesu oblikovanja prostora

Posljednjih desetak godina virtualna i proširena stvarnost te tehnologija povezana s njima ubrzano se razvijaju i pronalaze primjenu u svakodnevnom životu. Virtualna stvarnost koristi se računalno generiranim slikama i zvukovima te drugim osjetima kako bi korisniku omogućila interakciju s virtualnim prostorom. Svoju primjenu sve češće pronalazi u oblikovanju prostora i njegovu približavanju krajnjemu korisniku. Korisnik se, koristeći se posebnom opremom, kreće unutar virtualnoga svijeta i koristi se značajkama sustava i predmeta koji su prikazani. U tome području najveći napredak u posljednje vrijeme napravila je tvrtka Oculus VR svojim uređajem OculusuRift, koji ima u sebi integrirane slušalice i vidno polje od 110 stupnjeva. Za razliku od nje, proširena stvarnost preklapa virtualni i stvarni svijet, tj. nadopunjuje stvarni svijet računalno generiranim elementima. Proširena stvarnost korisniku omogućuje dodatne informacije o okolnome prostoru i objektima u njemu. Informacije o okolini i objektima preklapaju se sa stvarnim svijetom. Koristeći se vlastitim pametnim telefonima korisnici imaju mogućnost vizualizacije opremanja namještajem bez kupovine i montaže kako bi dobili dojam izgleda prostora nakon opremanja. Tvrtka Ikea je 2013. omogućila svojim kupcima da s pomoću aplikacije i pametnih telefona proizvode iz vlastitoga kataloga smjeste unutar svojega doma putem proširene stvarnosti. Vizualizacijom u realnome prostoru poboljšana je vizualizacija kupcima te je omogućena bolja međusobna komunikacija klijenata, dizajnera i konstruktora.

S obzirom na to da već sada klijenti traže prezentaciju modela proizvoda ili prostora u 3D prikazu, a virtualna i proširena stvarnost doživljava svoj procvat, pretpostavlja se da će ta tehnologija kroz idućih 10-ak godina u prodaji namještaja i ponudi opremanja objekata u potpunosti zamijeniti vizualizaciju u 2D projekciji.





Type of work: Seminar paper in the course Constructions of Wooden Products 4
Author: Lovro Belina
Mentor: Silvana Prekrat, PhD, Associate Professor
Title: Virtual and augmented reality in the spatial design process

Over the past decade, a virtual and expanded reality and the associated technologies have been rapidly developing, and finding applications in daily life. Virtual reality is used to generate a computer image with sounds and other sensory information, in order to enable the user to interact with the virtual space. It is increasingly finding applications in spatial design and making its use easy for end users. The user uses special equipment to move about in the virtual world, using properties of the system and objects shown. The greatest progress in recent years has been shown by the company Oculus VR with its OculusRift device, which includes integrated earphones and a field of view of 110 degrees. Unlike virtual reality, augmented reality overlaps the virtual and the real world, i.e. supplementing the real world with computer generated elements. Augmented reality provides the user with additional information about the surrounding space and objects within it. Environmental information and objects overlap with the real world. By using their own smart phones, users have the opportunity to visualise furniture without purchasing or assembling it, in order to get an idea of how the space will look once furnished. In 2013, the company IKEA enabled its customers to use its application and their own smartphones to position items from their catalogues into their home using augmented reality. Visualisation in real space improves customer visualisation, enabling better communications between clients, designers and constructors.

Since clients already seek presentations of model products or spaces in 3D views, and virtual and augmented reality are rapidly expanding, it can be assumed that over the next decade, this technology will completely replace visualisation in 2D views for the sale of furniture and for spatial design.



Lucija Brglez

Mobilni kuhinjski ormarić

Mobile kitchen cabinet

Vrsta rada: Seminar na predmetu Projektiranje proizvoda od drva

Autor: Lucija Brglez

Mentor: Izv. prof. dr. sc. Silvana Prekrat

Naslov: Mobilni kuhinjski ormarić

Projektiranje mobilnoga kuhinjskog ormarića temelji se na problemima koje su navele anketirane osobe. Nedostatak radne površine u kuhinji kao centralni problem rezultirao je metodološkim pristupom odabira konstrukcijskoga rješenja otklapanja radne ploče ormarića. Istraženi su različiti otklopni mehanizmi. Važnost kvalitete okova prepoznali su i ispitanici, a samo 2 % njih smatra kvalitetu okova nevažnom.

Ormarić je dimenziono prilagođen pohrani posuđa i pribora te je smješten ispod radne ploče. Odmicanjem i otklapanjem ploče ormarić postaje stol. S obzirom na okove predviđene su inačice za nosivost 30 i 159 kg.

Konstrukcija korpusa ormarića izvedena je rastavljivim okovom (svornjacima sa zakretnim klinom). Materijal je izrade za korpus oplemenjena iverica s folijom debljine 18 mm, a radna ploča oplemenjena ploča iverice laminatom.

Kotači učvršćeni na pod korpusa omogućuju mobilnost pa ormarić može služiti i kao pomoćni stol za posluživanje.

Type of work: Seminar paper on the course Designing of Wooden Product

Author: Lucija Brglez

Mentor: Silvana Prekrat, PhD, Associate Professor

Title: Mobile Kitchen Cabinet

The design of a mobile kitchen cabinet was based on the problems listed among surveyed persons. The lack of work space in the kitchen was listed as the main issue, which resulted in the methodological approach to selecting a construction solution for a fold away counter of the cabinet. Various folding mechanisms were examined. The importance of the quality of fittings was also recognised by those surveyed, with only 2% responding that fitting quality was insignificant.

The cabinet dimensions are adapted for the storage of dishes and utensils, and for placement under a counter top. By moving it away from the counter and unfolding the top, the cabinet becomes a table. With regard to hinges, two versions were proposed, one for a load of 30 kg and the other for a load of 159 kg.

The construction of the cabinet body was built with divisible fittings (shackles with rotating bolt). The corpus material is melamine faced 18 mm particle board, and the countertop is a laminated particle board.

The wheels affixed to the bottom of the body make the cabinet mobile, enabling it to serve as an auxiliary serving table.

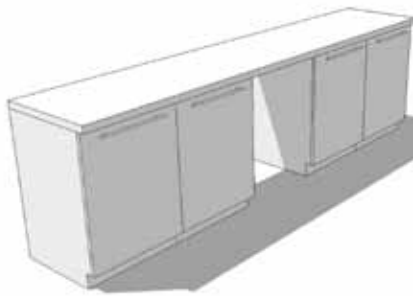
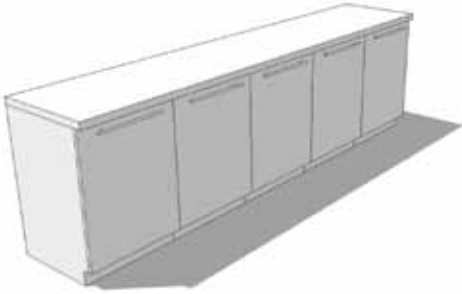

Franciska Klanfar

3d skeneri i primjena u drvnoj industriji

3D scanners and their applications in the wood industry

Vrsta rada: Seminar na predmetu Konstrukcije proizvoda od drva 4

Autor: Franciska Klanfar

Mentor: Izv. prof. dr. sc. Silvana Prekrat

Naslov: 3d skeneri i primjena u drvnoj industriji

Prema nedavnome istraživanju koje je provela agencija Marketsandmarkets, tržište za 3D skeniranje rast će 15 % godišnje u sljedećih pet godina, a 3D skeniranje prijenosnim 3D skenerima predvodit će taj trend.

Trodimenzionalni objekti najčešće se skeniraju kako bi se utvrdile dimenzije potrebne za rekonstrukciju CAD modela, koji se rabi u procesu povratnoga inženjerstva ili za brzu izradu prototipa te radi analize i dokumentiranja.

Podatci dobiveni skeniranjem prikazuju se koristeći se nestrukturiranim trodimenzionalnim podacima, najčešće u obliku oblaka točaka ili triangulacijske mreže.

Izrada proizvodne konstrukcijske dokumentacije dijelova složene geometrije gotovih modela namještaja od naručitelja gotovo je nemoguća bez preuzimanja koordinata točaka s fizičkoga modela u CAD model. Dosad se taj postupak najčešće izvodio kontaktnim skenerima koji su za današnje pojmove spori. Nedostatak brzine preuzimanja točaka povećava se složenošću geometrije elementa ili proizvoda.

Sve manjom cijenom beskontaktni skeneri postaju pristupačniji i služe kao nezaobilazan alat u drvnoprerađivačkoj industriji. Beskontaktni aktivni 3D skeneri pojavljuju se u obliku prijenosnoga sustava te su oni najbolji za oblike ravnoga profila ili jednostavne konveksne površine. CMM (Coordinate Measuring Machine) se najviše rabi u proizvodnji i odlikuje ga velika preciznost. Beskontaktni pasivni 3D skeneri pojavljuju se u obliku stereoskopskih ili fotometrijskih sustava i kao siluetna tehnika. 3D skeneri postali su nezaobilazan alat u svakome koraku životnoga ciklusa proizvoda te je njihova uporaba našla široku primjenu u drvnoj industriji: od utvrđivanja grešaka na trupcima i kontrole dimenzija do skeniranja ljudi za potrebe dimenzioniranja personaliziranoga namještaja.





Type of work: Seminar paper in the course Constructions of Wooden Products 4
Author: Franciska Klanfar
Mentor: Silvana Prekrat, PhD, Associate Professor
Title: 3D scanners and their applications in the wood industry

According to a recent survey conducted by the agency Marketsandmarkets, the market for 3D scanning will be increasing 15% annually for the next five years, with 3D scanning using mobile 3D scanners leading this trend.

Three-dimensional objects are most often scanned in order to determine the dimensions needed for reconstruction in CAD models, for use in reverse engineering processes or for the rapid development of prototypes, and for analysis and documentation.

The data obtained from scanning are depicted using non-structural three-dimensional data, most often in the form of cloud points or a triangulation network.

The development of the product construction documentation, particularly the sections of the complex geometrics of the finished furniture models from the client, are virtually impossible without taking the point coordinates from the physical models in the CAD model. To date, this procedure was most often performed using contact scanners, which are too slow in present day terms. The lack of speed of taking points further increases with the complexity of element or product geometry.

With decreasing prices, contact-free scanners are becoming more accessible and serve as an unavoidable tool in the wood processing industry. Contact-free active 3D scanners appear in the form of mobile systems and are best for straight profile forms or simple convex shapes. The CMM (Coordinate Measuring Machine) is most often used in production and is marked by great precision. Contact-free passive 3D scanners are available in the form of stereoscopic or photometric systems, and as silhouette techniques. 3D scanners have become an unavoidable tool in every step of the life cycle of the product, and their use is widely applicable in the wood industry: from detecting shortcomings in logs and control of dimensions, to scanning people for the purposes of creating dimensions for personalised furnishings.



Igor Kolman

Drvene kuće

Wooden houses

Vrsta rada: Seminar na predmetu Specijalni proizvodi od drva

Autor: Igor Kolman

Mentor: Izv. prof. dr. sc. Tomislav Sinković

Naslov: Drvene kuće

U ovome je seminarskom radu obrađena tema drvenih kuća kao autohtonih građevina našega područja sa svojim arhitektonskim oblikom. Rad je obradio upotrebu drva u drvenim kućama u smislu prirodnoga materijala. Također su prikazani i razlozi građenja drvenih kuća, obrazloženi prikazanim pozitivnim svojstvima drva kao materijala. Navedeni su i tipovi drvenih kuća s obzirom na vrstu drvene građe.

Type of work: Seminar paper in the course Special Products of Wood

Author: Igor Kolman

Mentor: Tomislav Sinković, PhD, Associate Professor

Title: Wooden houses

This seminar paper considers wooden houses and their architectural form as indigenous structures of this region. The paper addressed the use of wood in wooden houses in terms of natural materials. The reasons for the construction of wooden houses, and the positive properties of wood as a material, are presented. The types of wooden houses based on timber type were listed.



Margareta Kovačević

Blagovaonička komoda

Dining room cabinet

Vrsta rada: Seminar na predmetu Projektiranje proizvoda od drva

Autor: Margareta Kovačević

Mentor: Izv. prof. dr. sc. Silvana Prekrat

Naslov: Blagovaonička komoda

Projekt blagovaoničke komode temeljen je definiranjem problema dostupnosti pohranjenoga posuđa, pribora za jelo i piće, blagovaoničkoga tekstila i različitih boca za alkoholna pića.

Idejne skice inspirirane su oblikovnim rješenjem 50-tih godina prošloga stoljeća koji karakteriziraju zaobljenja. Komoda je asimetrična, pa je zaobljenje na lijevoj strani komode izvedeno vertikalno na bočnim vratima, a s desne strane horizontalno između stropa i stranice komode.

Većina anketiranih potencijalnih korisnika odabrala je cjelovito (masivno) drvo za materijal izrade.

Za materijal je odabrana jelova dužinsko širinski lijepljena ploča u izvedbi niskoga cjenovnog razreda te širinski lijepljene hrastove ploče za visoki cjenovni razred.

Obje inačice polica debljine 18 mm zadovoljavaju definirano kontinuirano opterećenje. Za predloženo rješenje masa komode od jelovine iznosi 123 kg, a od hrastovine 195 kg. Konstrukcija i dimenzioniranje nožišta projektirano je s dodatnim faktorom sigurnosti.

Type of work: Seminar paper on the course Designing of Wooden Products

Author: Margareta Kovačević

Mentor: Silvana Prekrat, PhD, Associate Professor

Title: Dining room cabinet

The dining room cabinet project was based on defining the issues of accessibility of stored dishes, utensils and glasses, dining linens and various bottles for the alcoholic drinks.

The idea sketches were inspired by 1950s furniture solutions, characterised by rounded shapes. The cabinet is asymmetrical, and the rounding on the left side is executed vertically to the side doors, while on the right side it is horizontal between the top and sides of the cabinet.

The majority of surveyed potential users preferred massive wood for the construction material. The selected material was fir finger-joint panels for the lower cost version, and oak one-ply laminated panels for the higher price range.

Both versions have 18 mm thick shelves, thereby satisfying the defined continuous load. For the proposed solution, the fir cabinet has a mass of 123 kg, while the oak cabinet has a mass of 195 kg. The construction and dimensions of the legs were designed with an additional safety factor.



Ana Mišetić

—
Poličar za knjige
Bookshelf

Vrsta rada: Seminar na predmetu Projektiranje proizvoda od drva

Autor: Ana Mišetić

Mentor: Izv. prof. dr. sc. Silvana Prekrat

Naslov: Poličar za knjige

U radu je projektiran poličar kroz faze razvoja koje čine životni vijek proizvoda.

Problem koji se često javlja kod takve vrste proizvoda jest progib koji nastaje uslijed kontinuiranoga opterećenja, puzanja i slabljenja savojne čvrstoće. Upravo stoga u ovome je radu naglasak na rješenju problema savojne čvrstoće ne narušavajući estetska svojstva.

Pri projektiranju korištene su norme namještaja za odlaganje, a odgovarajući materijal potvrđen je izračunom progiba police. Projektni zadatak definiran je uvjetima i traženim karakteristikama namještaja za odlaganje i pohranu knjiga te dekorativnih predmeta za kućanstvo dobivenim anketiranjem potencijalnih korisnika.

Projekt poličara izveden je u srednjemu cjenovnomu razredu, a u skladu s definiranim budžetom kao materijali razmatrani su MDF ploča, furnirska ploča, Eurolight laka ploča sa srednjicom od papirnoga sača debljine 38 mm, cjelovito (masivno) drvo nižega cjenovnog razreda.

Potrebni podatci modula elastičnosti i volumne mase preuzeti su iz literature. Oplemenjenost ploče folijom tekture hrastovine dobivena je anketiranjem. Ekonomski optimalno rješenje obrazloženo je metodološkim pristupom odabira konstrukcijskoga i tehnološkoga rješenja u interakciji s materijalom od kojega je izrađen proizvod.

Type of work: Seminar paper on the course Designing of Wooden Products

Author: Ana Mišetić

Mentor: Silvana Prekrat, PhD, Associate Professor

Title: Bookshelf

The paper outlines the design of a bookshelf throughout the development phases making up the product lifetime.

An issue that often appears with this type of products is a deflection arising from continued load, and the weakening of the bending strength. For that reason, the focus of this paper is on resolving the issue of bending strength without degrading the aesthetic properties.

In design, the standards for storage furniture were used, and the appropriate material was confirmed with a calculation of shelf deflection. The project task defined the conditions and the sought characteristics of the shelving for the storage of books and decorative household items obtained from a survey of potential users.

The bookshelf project was designed to be in the mid-price range, in accordance with the defined budget. The considered materials were MDF panels, veneer panels, 38 mm Euro-light panels with paper comb centre, massive wood in the lower price category.

The necessary data for the elasticity module and mass volume were taken from the literature.

Enrichment of the panels with oak texture foils was obtained by surveying. The economically optimal solution was described using a methodological procedure to select a construction and technological solution in interaction with the material used to build the product.

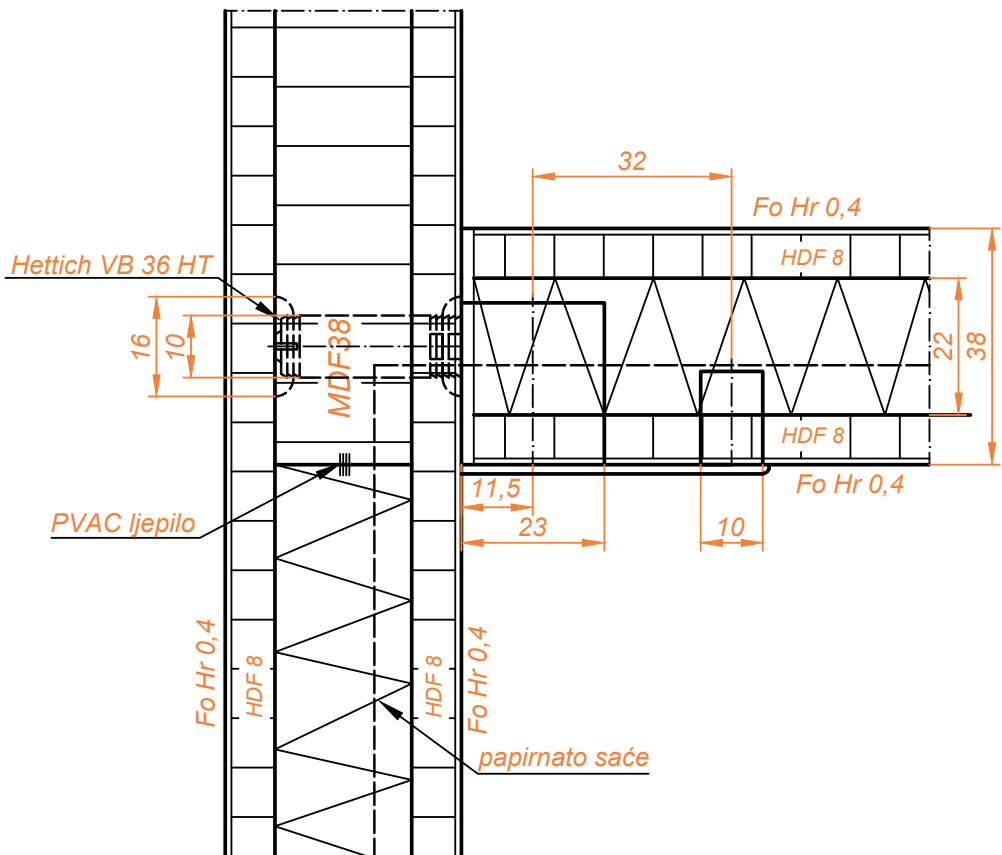

Lovro Belina, Ivana Hideg, Franciska Klanfar, Igor Kolman, Domagoj Mamić, Tomica Perković, Ivan Ražov, Valentino Slivar, Juraj Tomljanović

Projektni zadatak studenata diplomskoga studija Oblikovanje proizvoda od drva u sklopu predmeta Sustavi informacija na tržištu drvnih proizvoda

Student project within the course Information Systems on the Wood Products Market as part of the graduate study programme Wood Product Design

Vrsta rada: Projektni zadatak studenata diplomskoga studija Oblikovanje proizvoda od drva u sklopu predmeta Sustavi informacija na tržištu drvnih proizvoda

Autor: Lovro Belina, Ivana Hideg, Franciska Klanfar, Igor Kolman, Domagoj Mamić, Tomica Perković, Ivan Ražov, Valentino Slivar, Juraj Tomljanović

Mentor: Prof. dr. sc. Darko Motik, doc. dr. sc. Andreja Pirc Barčić

Naslov: Uporaba proizvoda od drva u turističkim objektima ruralnoga turizma

Drvena industrija čini jednu od vrlo važnih industrijskih grana gospodarstva Republike Hrvatske, dok je sektor ruralnoga turizma važno područje hrvatskoga gospodarstva u kojemu je moguć velik stupanj uključenosti i korištenja drva i proizvoda od drva. Cilj je projektnoga zadatka bio analizirati uporabu različitih kategorija proizvoda od drva u poslovnim subjektima koji se bave aktivnostima povezanim s ruralnim turizmom na području Republike Hrvatske. S obzirom na to da navedena djelatnost za proizvođače namještaja i proizvoda od drva čini važan segment potencijalnih kupaca i korisnika, od iznimne je važnosti bilo dobiti uvid u stanje i potrebe tih poslovnih subjekata jer se privlačnost turističke destinacije, između ostaloga, očituje u autentičnosti i jedinstvenosti ambijenta.

Rezultati istraživanja prezentirani su na 9. znanstvenoj međunarodnoj konferenciji WoodEMA 2016 – “The Path Forward for Wood Products: A Global Perspective”, koja je u listopadu 2016. održana u Sjedinjenim Američkim Državama (Baton Rouge, Louisiana).

Type of work: Student project within the course Information systems on the wood products market as a part of the graduate study program Wood Product Design
Author: Lovro Belina, Ivana Hideg, Franciska Klanfar, Igor Kolman, Domagoj Mamić, Tomica Perković, Ivan Ražov, Valentino Slivar, Juraj Tomljanović
Mentor: Prof. Darko Motik, Ph.D.; Andreja Pirc Barčić, PhD, Assistant Professor
Title: Wood products usage in rural tourism facilities

The wood industry is one of the most important sectors of the Croatian economy, while the rural tourism sector is an important economic branch where the possibilities for use of wood products are broad. The aim of the study was to identify the possibilities of use of wood products in rural tourism facilities in Croatia. Considering that businesses in rural tourism are a significant segment of potential buyers and users for wood industry companies, it was extremely important to gain insight and information, and the attractiveness of the tourism destinations is also reflected in the authenticity and integrity of its interior.

The project results were presented at the 9th International Scientific Conference WoodEMA 2016: The Path Forward for Wood Products: A Global Perspective, held in Baton Rouge (Louisiana, USA) in October 2016.

Medupredmetni projekti

–

Interdisciplinary projects

Kako zavoljeti Konstrukcije proizvoda od drva? Kućice za ptice

How to get to love Construction of Wooden Products? Bird houses

Voditeljica projekta: Izv. prof. dr. sc. Silvana Prekrat

Stručni suradnik: Doc. dr. sc. Vjekoslav Živković, Doc. dr. sc. Goran Mihulja

Sudionici na projektu

Studenti 3. semestra preddiplomskoga studija Drvena tehnologija

Antolković Josip, Barlović Nikolina, Buterin Petra, Cvetko Matija, Čošković Antun, Gabrek Gustav, Golić Goran, Gotovac Jakov, Graho Josip, Gržan Tomislav, Herceg Franjo, Ivančić Ivan, Jurić Jozo, Koščec Mateo, Kozina Vedrana, Krčelić Petra, Kremenjaš Karla, Lacković Vinko, Lasić Mislav, Lončarić Andrea, Lovrić Ivana, Mandić Luka, Marković Lucija, Martišković Dario, Mihić Mijo, Mogorović Mihaela, Mršić Đarko, Nikić Velimir, Novosel Dario, Pavić Katarina, Pečur Josipa, Smažil Luka, Šehagić Mirsad, Šušković Mateo, TretinjakĐejan-Josip, Varvoda Lucija, Veseličić Nikolina, Željковиć Dominik

Studenti 2. semestra diplomskoga studija Drvnotehnološki procesi

Pernar Zrinko, Jarža Lana, Oroz Bruno, Nakić Matija, Luke Marko, Petričević Katarina, Perić Miran, Jovanović Josip Zanić Luka, Jelonjić Drago, Fazlić Demir

Ideja projekta „Kućice za ptice” izrasla je iz potrebe za boljim razumijevanjem ortogonalnoga projiciranja koje je temeljno za daljnje savladavanje gradiva za konstruiranje proizvoda od drva. Na temelju anketiranja studenata i izvršenoga inicijalnog kolokvija zapažen je pad u početnome predznanju. Broj studenata koji su završili drvenu strukovnu školu u opadanju je zajedno s brojem studenata koji su pohađali neku od tehničkih škola, dok broj studenata koji su maturirali na strukovnim školama ugostiteljskoga, frizerskoga, terapijskoga ili nekoga drugog netehničkoga smjera raste.

Projektni zadatak vježbe iz kolegija Konstrukcije proizvoda od drva 1, koji se sluša u 3. semestru preddiplomskoga studija, trebao je sadržavati jednostavan sklop. Formiranje individualnih zadataka koji po svojoj prirodi trebaju biti podjednake složenosti, dugogodišnja je praksa u navedenome predmetu, a pronalaženje dimenzija kućica za 31 vrstu ptica te relativno jednostavna geometrija proizvoda bila je idealna za ostvarenje projekta.

Izrada maketa od stiropora u M 1 : 1 pružala je bolji trodimenzionalni uvid te su studenti samostalno mogli uvidjeti nastalu pogrešku u izrađenoj dokumentaciji, nakon čega su samostalno mogli izvršiti korekcije.

Projekt je nadopunjen suradnjom sa studentima 1. god. diplomskoga studija Drvnotehnološki procesi, koji su upisali izborni kolegij CNC tehnika. Zajedničkim radom studenti su surađivali simulirajući stvarne uvjete suradnje konstruktora i tehnologa. Rezultat ove suradnje ogleda se u proizvedenim drvenim kućicama.

Project leader: Silvana Prekrat, PhD, Associate Professor

Expert associate: Vjekoslav Živković, PhD, Assistant Professor, Goran Mihulja, PhD, Assistant Professor

Participants in the project

Students of the 3rd semester of the undergraduate study programme Wood Technology

Antolković Josip, Barlović Nikolina, Buterin Petra, Cvetko Matija, Čošković Antun, Gabrek Gustav, Golić Goran, Gotovac Jakov, Graho Josip, Gržan Tomislav, Herceg Franjo, Ivančić Ivan, Jurić Jozo, Koščec Mateo, Kozina Vedrana, Krčelić Petra, Kremenjaš Karla, Lacković Vinko, Lasić Mislav, Lončarić Andrea, Lovrić Ivana, Mandić Luka, Marković Lucija, Martišković Dario, Mihić Mijo, Mogorović Mihaela, Mršić Darko, Nikić Velimir, Novosel Dario, Pavić Katarina, Pečur Josipa, Smažil Luka, Šehagić Mirsad, Šušković Mateo, TretinjakDejan-Josip, Varvoda Lucija, Veseličić Nikolina, Željковиć Dominik

Students of the 2nd semester of the graduate study programme Wood Technology Processes

Pernar Zrinko, Jarža Lana, Oroz Bruno, Nakić Matija, Luke Marko, Petričević Katarina, Perić Miran, Jovanović Josip Zanić Luka, Jelonjić Drago, Fazlić Demir

The idea for the project 'Bird Houses' arose from the need for a better understanding of the orthogonal projections which are the foundation for further mastery of the knowledge of constructing products from wood. An initial survey of students and an initial knowledge test indicated a lack of the necessary prerequisite knowledge. The number of students completing trade school for the wood industry and those who completed technical schools is dropping, while the number of students enrolling from hospitality, hairdressing, therapy or other non-technical programmes is rising.

The project task of the exercise from the course Construction of Wood Products 1, which is taken in the 3rd semester of the undergraduate study, should contain a simple structure. Creating individual tasks which should be of uniform complexity has been a traditional practice in this course, and finding the dimensions for bird houses for 31 different birds species, and the relatively simple product geometry of this structure made it ideal for this project.

The construction of a styrofoam model in the scale M 1:1 gave students a better 3D view, enabling students to see where errors had been made in the prepared documentation, allowing them to independently make corrections.

The project was complemented through cooperation with students in the 1st year of the graduate study programme Wood Technology Processes, who had enrolled in the elective course CNC techniques. By working together, students simulated actual conditions through the cooperation of designers and technologists. The results of this cooperation are best seen in the produced bird houses.



M 1:1

Prednjak 35.01

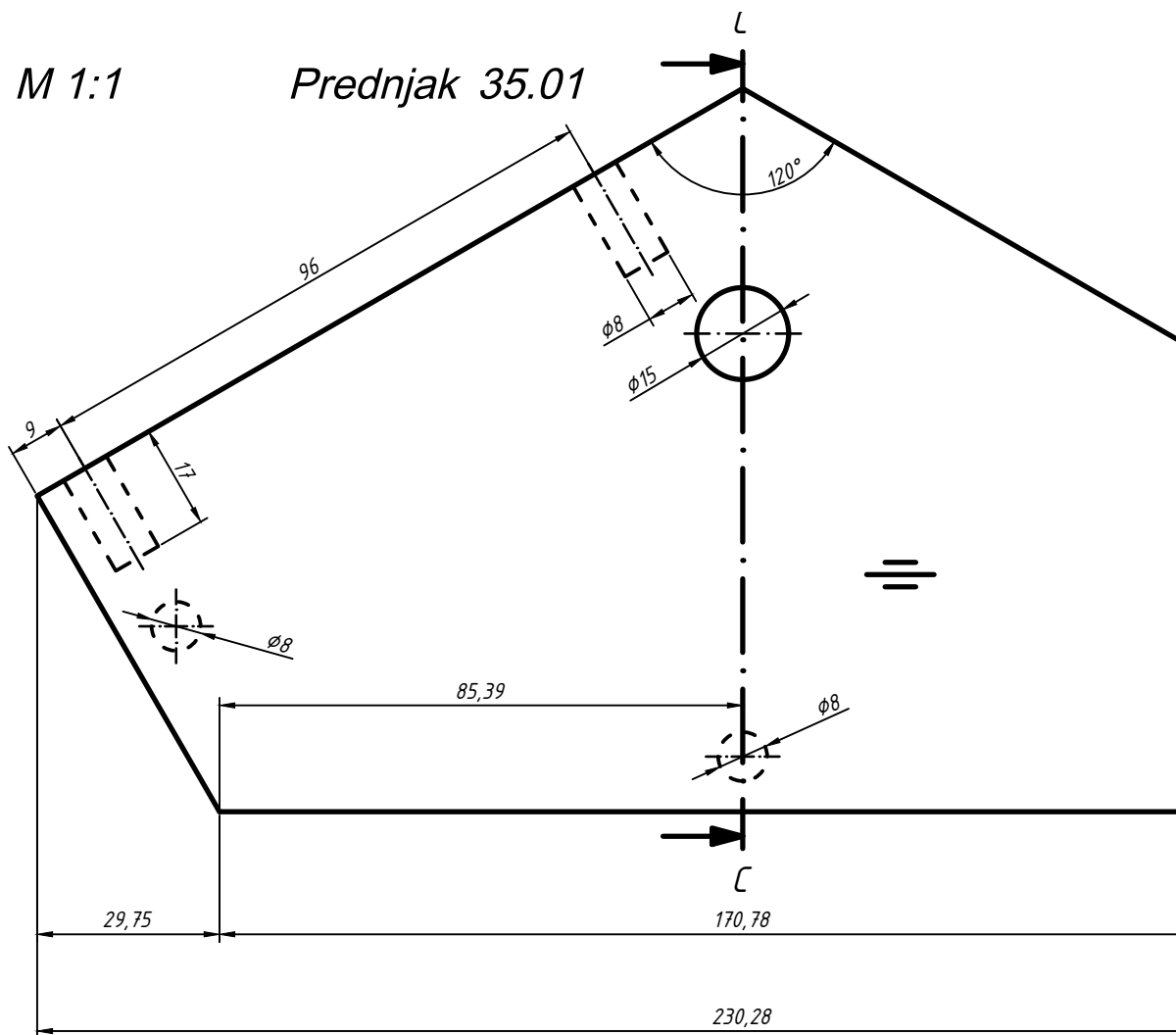

Izvannastavna aktivnost

–

Extracurricular activities

Izvannastavne aktivnosti realiziraju se periodično prema potrebi, a odnose se uglavnom na dopunsku nastavu potrebnu studentima koji imaju nedostatke temeljnih znanja koje su trebali usvojiti u srednjoškolskom obrazovanju. Da bi se pomoglo studentima u savladavanju gradiva, održava se povremeno nastava na kojoj se ponavlja gradivo koje studenti nisu savladali, a nužno je za razumijevanje sadržaja kolegija.

Izvannastavna aktivnost održava se i za one koji žele naučiti nešto više izvan zadanoga programa. Takvi se studenti uključuju u postojeće znanstvene ili stručne projekte u kojima sudjeluju nastavnici ili se organiziraju novi projekti sa zadanom temom koji okupljaju grupe studenata obično s različitih godina studija. Jedan takav projekt bio je rekonstrukcija i opremanje učionice za e-učenje.

Extracurricular activities take place periodically as required, and pertain primarily to additional classes needed by students lacking the fundamental knowledge that should have been mastered during secondary education. In order to assist students in mastering the materials, lectures are held periodically to repeat the course materials that students have yet to master, and is necessary for understanding the course content.

Extracurricular activities are also held for those wanting to learn more than what is given in the programme. Such students are included in existing scientific or professional projects with participating lecturers or new projects are organised on a given topic for groups of students, typically from different study years. One such project was the reconstruction and equipping of an e-learning classroom.

Projektiranje učionice za e-učenje

Design of an e-learning classroom

Oprema objekata drvnim materijalima i namještajem jedna je od djelatnosti koju izvode stručnjaci koje školujemo. U području opremanja objekata posao stručnjaka koji se bave implementacijom drva i drvnih materijala u interijer odnosi se najčešće na izradu proizvodne dokumentacije i pripremu proizvodnje namještaja i drvnih proizvoda te zidnih i podnih obloga i pregrada. Rekonstrukcija i projektiranje učionice za e-učenje jedan je od svakodnevnih zadataka u realnome sektoru. Kako u redovnoj nastavi ne postoji kolegij koji bi uz projektiranje namještaja i obloga sadržavao i rubna područja koja se tiču rekonstrukcije i inženjerskoga projektiranja učionica, oformio se tim studenata koji su željeli naučiti nešto više te je uz voditeljicu projekta tijekom godine dana ostvaren projekt s proizvodnom dokumentacijom i troškovnikom. Na kraju uspješno izrađene dokumentacije izvršena je prezentacija na kojoj su osim projekta prezentirani i računalni programi potrebni za rad u takvu tipu učionice. Dotrajala učionica kojom se već nekoliko godina ne koristi bila je izvrstan poligon za učenje o inženjerskome projektiranju, a predviđena realizacija projekta studentima je bila velik poticaj za rad koji se uglavnom odvijao nakon odslušane redovne nastave u prosječnome trajanju 4 sata tjedno kroz 8 mjeseci.

Iako je na početku bilo više zainteresiranih studenata, iz raznih razloga projekt je realiziralo troje studenata: Ana Mišetić, Lana Jarža i Valentino Slivar. Oni su uz projektiranje namještaja, podnih i zidnih obloga temeljno istražili propise za projektiranje informatičkih učionica u koje je uključeno projektiranje mrežnih i električnih instalacija, ispitivanje i prijedlog izvedbe toplinske i zvučne izolacije. Pri odabiru materijala studenti su bili vođeni istraživanjima utjecaja boja, biljaka i drva u interijeru i njihova učinka na produktivnost rada. Studenti su od ukupno 6 koncepata razmještaja namještaja u prostoru razradili 2, koja su odabrali postavljanjem kriterija definiranih potrebama i željama korisnika. Razradili su dokumentaciju za 3 različita oblikovna rješenja garniture koju sačinjavaju studentski i nastavnički stol, govornica, stolica, vješalica, komoda za printer te zidna obloga. Na predstavljanju projekta javnosti, koja se održala 2. lipnja 2016., odabrano je oblikovno rješenje učionice s potrebnim namještajem i opremom. U predstavljanju projekta sudjelovali su studenti koji su izdržali naporan tempo do kraja izrade projekta: Ana Mišetić, Lana Jarža i Valentino Slivar te voditeljica projekta izv. prof. dr. sc. Silvana Prekrat. Dvosatni program prezentacije održao je pozornost publike, koja je s pomoću sustava za glasovanje odabrala jedno od projektnih rješenja čija je realizacija započela radovima u srpnju 2016. godine. Tako obiman projekt prvi je put realiziran na našem fakultetu, a studenti su imali priliku raditi na stvarnome projektu i ujedno vidjeti rezultat svojega rada, koji će, nadamo se, poslužiti budućim korisnicima. Fakultetu je projektom uštedio sredstva za izradu projektne dokumentacije, izrade troškovnika i nadzora izvođenja radova.

Equipping structures with wood materials and furnishings is one of the activities performed by the experts we have educated. In the field of equipping structures, the task of the expert for the implementation of wood and wooden materials in interiors most often involves developing the product documentation and preparations for the production of furniture and wood products, and floor and wall panels and dividers. The reconstruction and design of the e-learning classroom is certainly one of the daily tasks in the real world. Since regular classes do not include classes that, in addition to designing furnishings and panels, also deal with the reconstruction and engineering design of classrooms, a team of students wanting to learn more was formed. Together with the project leader, over the course of the year, they completed a project to develop the product documentation and budget. Finally, the successfully completed documentation was presented, and the project also included a presentation of the computer software necessary for this kind of work. An old classroom that had already been out of function for several years was the perfect place to learn about engineering design, and through execution of the project, students received a great stimulus to work. This work primarily took place after regular classes, and on average encompassed four hours per week over eight months.

Though there were more interested students at the beginning of the project, many left the project for various reasons, and three students completed the project: Ana Mišetić, Lana Jarža and Valentino Slivar. In addition to designing the furniture, floor and wall panels, they conducted a comprehensive search of the regulations for the design of IT classrooms, including the design of network and electrical installations, testing and the proposed execution of heat and sound insulation. In the selection of materials, students were guided by research on the influence of colours, plants and wood in interiors and their effects on work efficacy. Of the total of six concepts for the layout of furniture in the space, the students selected two concepts to work out in detail, based on the criteria defined by the needs and desires of the users. They drafted the documentation for three different form solutions of the furniture, including student and teacher desks, a podium, chairs, hangers, a printer cabinet and wall panels. The project was presented publicly on 2nd June 2016, when the final form design of the classroom with the necessary furnishings and equipment was selected. The students also participated in the presentation of the project, and held up to the pressure of the project until its very completion: Ana Mišetić, Lana Jarža and Valentino Slivar, and project leader, Silvana Prekrat, PhD, Associate Professor. The two-hour presentation kept the public's attention, and a voting system was implemented to select one of the project solutions. Reconstruction works began in July 2016. This is the first time such a comprehensive project has been carried out at our faculty, and students had the opportunity to work on a real project and see the

Koncept 1



Koncept 2



Koncept 3





Izvanfakultetska suradnja

–

Out of faculty cooperation

Izvanfakultetska suradnja bila je vrlo uspješna i raznolika, a svaka od njih donosile su bogata iskustva kako za mentore tako i za studente. Neke od njih, kao što je suradnja s udrugom HRAST, rezultirale su idejnim rješenjima proizvoda od kojih su izvedeni prototipovi. Suradnja s tvrtkom Bokart omogućila je studentima upoznavanje s procesom proizvodnje stakla, a stečeno znanje upotrijebili su ugrađivši ga u novooblikovane stolove. Suradnja s Etnografskim muzejom omogućila je studentima da se okušaju u umjetničkome području oblikovanja utemeljena na baštini.

Interfaculty cooperation was very diverse and successful, and each project resulted in an excellent experience for both mentors and students. Some projects, such as the cooperation with the HRAST Association, resulted in design concepts for products and the making of their prototypes. Cooperation with the company Bokart enabled students to learn more about the glass production process, and the acquired knowledge was used in embedding this glass into newly designed tables. The cooperation with the Ethnographic Museum enabled students to try their hand in the artistic field of heritage-based design.

Suradnja s udrugom HRAST

Cooperation with the HRAST Association

Vrsta rada: Suradnja s drvnim klasterom Slavonski hrast na projektu Razvoj novih proizvoda od slavonskoga hrasta - namještaj za opremanje obrazovnih institucija

Autori: Lovro Belina, Helena Borković, Ivana Hideg, Franciska Klanfar, Ivan Lacković, Tin Lojen, Ivan Ražov, Valentino Slivar, Josip Svilić, Melita Šomodi, Lana Jarža i Ana Mišetić te studenti Studija dizajna Arhitektonskoga fakulteta u Zagrebu Marta Badurina, Viktorija Jurina, Mihovil Karač

Mentor: Izv. prof. dr. sc. Silvana Prekrat, doc. dr. sc. Danijela Domljan

Cilj je projekta bio oblikovati namještaj na temelju poznavanja tehničkih, mehaničkih i fizikalnih svojstava hrastovine s isticanjem estetske vrijednosti materijala. Pritom je namještaj trebao zadovoljiti uvjete inovativnoga, višefunkcionalnoga namještaja koji odgovara suvremenim potrebama učenika i nastavnika u obrazovnim zgradama te koji primjenom dizajnersko-konstruktivskih metoda i načela potiče kreativnost, svjesnost o hrvatskoj baštini i hrvatskoj tradiciji te ekologiji i održivome razvoju.

U radu studenata došla je do izražaja sinergija kreativnosti, poznavanja svojstava materijala, principa oblikovanja i konstruiranja te tehnološke pripreme proizvoda.

Idejna rješenja višefunkcionalnoga stola za rad i izložbe te stola za računalo izvedeni su kao prototipovi, a cijeli je projekt prezentiran na nekoliko izložba.

Type of project: Cooperation with the Slavonian Oak wood cluster on the project Development of new products from Slavonian oak - furniture for equipping educational institutions

Authors Lovro Belina, Helena Borković, Ivana Hideg, Franciska Klanfar, Ivan Lacković, Tin Lojen, Ivan Ražov, Valentino Slivar, Josip Svilić, Melita Šomodi, Lana Jarža and Ana Mišetić and Design students at the Faculty of Architecture, University of Zagreb: Marta Badurina, Viktorija Jurina, Mihovil Karač

Mentor: Silvana Prekrat, PhD, Associate Professor, Danijela Domljan, PhD, Assistant Professor

The objective of the project was to design furniture on the basis of the knowledge of technical, mechanical and physical properties of oak with an emphasis on the aesthetic values of the materials. The furniture should meet the conditions of innovative, multi-functional furniture that corresponds to the contemporary needs of students and teachers in educational buildings, and which apply design and construction methods and principles to spur creativity, awareness of Croatia's heritage and Croatia's tradition, and ecology and sustainable development.

This project included a synergy of creativity, the knowledge of material properties, principles of form and construction, and technical product preparation.

The design concept of a multi-functional work table and the exhibition of that table were computer generated as prototypes, and the entire project was presented at several exhibits.

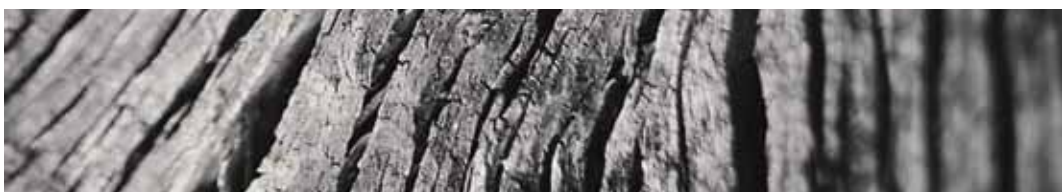
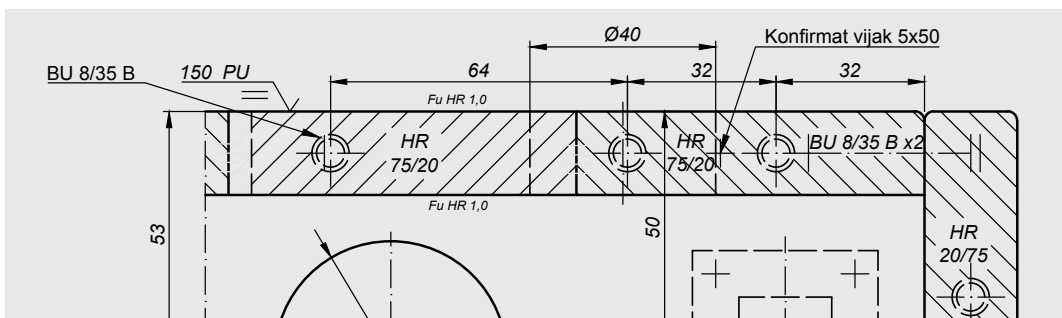

Suradnja s tvrtkom Bokart

Autor: Lovro Belina, Ivana Hideg, Lana Jarža, Igor Kolman, Margareta Kovačević, Domagoj Mamić, Tomica Perković, Ivan Ražov, Valentino Slivar i Juraj Tomljanović
Mentor: Doc. dr. sc. Danijela Domljan

Projekt je započeo kao izvannastavna aktivnost generacije kreativnih studenata diplomskog studija smjera Oblikovanje proizvoda od drva u suradnji s vodećom hrvatskom tvrtkom Bokart, proizvođačem dekorativnoga unikatnog stakla. Idejni pokretači projekta – direktor tvrtke Daniel Kvesić i doc. dr. sc. Danijela Domljan – osmislili su zadatak pod nazivom Oblikovanje klub-stolića od drva i stakla. Uz održano predavanje o vrstama i proizvodnji stakla, studenti su bili na jednodnevnoj terenskoj nastavi u tvrtci Bokart, gdje su imali praktičan uvid u proizvodnju različitih vrsta stakla. Projekt je rezultirao samostalnim nastupom deset studenata na posebnome izlagačkom prostoru Expoa, na kojemu su stolovi od drva i unikatnoga stakla plijenili pozornost posjetitelja i novinara (sl. 11). Studenti Lovro Belina, Ivana Hideg, Lana Jarža, Igor Kolman, Margareta Kovačević, Domagoj Mamić, Tomica Perković, Ivan Ražov, Valentino Slivar i Juraj Tomljanović osmislili su postav i letak te samostalno izradili prototipove uz donaciju stakla tvrtke Bokart.

Prototipovi su izrađeni uz pomoć brojnih tvrtka kao što su Bokart, Lipa, Pilana d. o. o., Stolarija Slivar, SRZ Lisak i ZGI interijeri, a neki od studenata dokazali su se vještinom samostalne izrade prototipa, pri čemu je i vrijedna inicijativa bila izrada stola na CNC stroju Šumarskoga fakulteta, koji je izveden uz pomoć doc. dr. sc. Gorana Mihulje.

Autori su u katalogu izložbe opisali svoja rješenja.

Lana Jarža – *Serious*

Stol „Serious” izrađen je od cjelovitoga drva u kombinaciji sa staklom. Jednostavne i ravne linije stolu daju elegantnost dok različiti prirodni tonovi drva uklopljeni u male letvice upotpunjuju staklenu površinu. Konstrukcija stola omogućuje korisnicama individualno postavljanje dijelova ploče stola ovisno o željama. Time je dana mogućnost pojedincu za vlastiti izražaj. Stol se izrađuje iz različitih vrsta drva, a time se mijenja i staklo unutar ploče koje također može biti unikatno obrađeno različitim tehnikama, ovisno o željama korisnika.

Margareta Kovačević – *Monde*

Klub-stolić „MONDE” konstrukcijom povezuje dva različita materijala – drvo i staklo. Gledajući na to, drvo djeluje toplo i čvrsto te podsjeća na prirodu i zemlju, dok staklo djeluje prozračno i lagano te podsjeća na nebo i zrak. Time je prikazan međusoban odnos dvaju materijala koji zajedno stvaraju sklad i ravnotežu u prostoru, pri čemu se konstrukcija stolića suočava sa Zemljinom gravitacijom – pokušava sve elemente držati povezane.

Ivana Hideg – *Kayla*

Jednostavan sklad elemenata stakla i drva obrađenoga tokarenjem pridonosi stolu elegantan izgled te konstrukcijsku lakoću i prozračnost. Jednostavno sastavljanje te rastavljanje elemenata omogućuju da stol ima sposobnost lakoga prenošenja s jednoga mjesta na drugo. Dodatnu elegantnost stolu daje kaljeno staklo koje je upušteno nasjedanjem otvora u staklu na drvenu konstrukciju. Uz pomoć drvenih klinova drvena konstrukcija postaje stabilnija unatoč tankim drvenim elementima.

Lovro Belina – *GlauWee*

„GlauWee” je stolić namijenjen za kafiće, dnevne boravke, noćne klubove, čekaonice. Izrađen iz drva i stakla, spoj je suprotnosti glatko-hrapavo, toplo-hladno koje se savršeno uklapaju, kao što mu i ime govori. U različitim inačicama može biti stolić s ladicom, s vratima, u različitim dimenzijama, prema želji kupca. Nudi mogućnost pohrane raznoga pribora za ugostiteljstvo i zabavu na prilično neprimjetan način.

Igor Kolman – Drvo života

Inspiracija za stolić potekla je iz stabla od kojega se dobiva drvo, što je jedna od glavnih sirovina za oblikovanje i konstruiranje proizvoda. Time se stvorila ideja: zašto ne od drva dobiti „stablo“, te je tako nastalo „Drvo života“ kao zajednički sklad struke, drva i prirode.

Domagoj Mamić – Dipole

Stolić je napravljen iz orahovine. Elementi su sastavljeni magnetima koji omogućuju brzo sastavljanje i rastavljanje. Stolić funkcionira okrenut u obje strane, dajući korisniku na odabir kako će se njime koristiti. Površinu stolića čini tonirano transparentno kaljeno staklo. Multifunkcionalnost proizvoda prema strani korištenja i upotreba magneta kao veznih elemenata (pol-magnetski pol) kreirala su ime: „Dipole“. Magneti korišteni u stoliću primjer su magnetskoga dipola, a to naglašava i dvostruka mogućnost primjene proizvoda.

Tomica Perković – Criss cross

Stolić je napravljen od hrastovine. Stol je moguće vrlo lako sastaviti te rastaviti jer se središnji elementi spajaju križno. Kaljeno staklo koje se nalazi na stoliću je matirano i debljine je 10 mm. Na središnjemu djelu stola vidljiva je dizajnerska ideja u kojoj drvo prodire kroz središte stakla te time ubija monotoniju oblika i sa staklom tvori zanimljivu kombinaciju tih dvaju materijala.

Ivan Ražov – Deep

Inspiracija za stolić pronađena je u moru. Prozirno plavo glatko staklo podsjeća na površinu mora kada je bonaca, dok more miruje, postepeno obojeno drvo u obliku čamca simbolizira sve veću dubinu mora.

Valentino Slivar – Lava Table

Lava Table, koji svojim kontrastom žarko crvene lave naspram hladnoj i hrapavoj površini stakla čini jedinstven spoj vizualnih elemenata, koji će unijeti toplinu u Vaš dom svjetlosnim efektima i njihovim refleksijama na raznim površinama. Iako u prvi plan dolaze upadljivi motivi lave, veći dio zauzima rotirajući sklop za pohranu, koji svojom blagom teksturom drva smiruje i neutralizira dinamiku staklene plohe. Ovaj je stolić idealan za korisnike koji vole inovativan i upadljiv dizajn koji dominira u svakome prostoru i stvara oku ugodno, toplo, ali i moderno rješenje prikladno za svakodnevnu uporabu.

Juraj Tomljanović – L table

Jednostavnost, luksuz i unikatnost su kvalitete koje opisuju stolić L.

Nožište stolića izrađeno je od masivnoga drva, na kojemu se nalazi visokokvalitetno fuzirano staklo. Konstrukcija nožišta čini stolić jednostavnim, ali zanimljivim, dok se fuziranim staklom, kao najkreativnijom obradom stakla, postiže jedinstven efekt i doza luksuza. S obzirom na to da tekstura drva nikada nije ista te da se svako fuzirano staklo posebno izrađuje, svaki je stolić unikat.

Cooperation with the company Bokart

Autor: Lovro Belina, Ivana Hideg, Lana Jarža, Igor Kolman, Margareta Kovačević, Domagoj Mamić, Tomica Perković, Ivan Ražov, Valentino Slivar i Juraj Tomljanović
Mentor: Doc. dr. sc. Danijela Domljan

This project began as an extracurricular activity for generations of creative students in the graduate study programme Wood Product Design, in cooperation with the leading Croatian company Bokart, a producer of decorative unique glass. The idea project was developed by Bokart director Daniel Kvesić and Dr. Danijela Domljan, who created a task entitled Design of wood and glass coffeetables. In addition to lectures on the types of glass and its production, students took a one-day field trip to Bokart, where they had a practical overview of the production of different types of glass. The project resulted in the individual exhibit of ten student works at the special design space Expo, where the wood and unique glass tables attracted the attention of visitors and the press (Fig. 11). Students Lovro Belina, Ivana Hideg, Lana Jarža, Igor Kolman, Margareta Kovačević, Domagoj Mamić, Tomica Perković, Ivan Ražov, Valentino Slivar and Juraj Tomljanović designed the exhibit layout and flyer, and independently built their prototypes using glass donated by Bokart.

The prototypes were built with the assistance of numerous companies, such as Bokart, Lipa, Pilana d. o. o., Stolarija Slivar, SRZ Lisak and ZGI interijeri, and some of the students proved their skills at making their own prototypes. A worthy initiative was the building of a table on the CNC machine at the Faculty of Forestry, which was built with the assistance of Dr. Goran Mihulja.

In the catalogue, the designers described their solutions.

Lana Jarža – *Serious*

The table “*Serious*” is built of massive wood in combination with glass. The straight and simple lines of the table give it elegance, while the different natural tones of the wood inlays enrich the glass surface. The construction of the table enables users to individually set up the parts of the table top as desired. This gives the individual the opportunity for their own expression. The table is composed of different types of wood inlays, and the glass within the panel can also be made uniquely using different techniques, depending on the user’s desires.

Margareta Kovačević – *Monde*

The coffee table “*MONDE*” has a structure made of two different materials – wood and glass. Looking at it, the wood gives a feeling of warmth and strength, reminiscent of nature and the Earth, while glass is light and airy, giving the feeling of the sky and air. This describes the mutual relationship of the two materials, that together create a harmonious balance in the room, in which the structure of the table is faced with the Earth’s gravitational pull – trying to hold all the elements together.

Ivana Hideg – *Kayla*

The simple harmony of the elements of glass and lathed wood gives this table an elegant appearance, while the construction is light and airy. The simple assembly and disassembly of elements allows the table to be readily mobile for movement from one place to another. Additional elegance is given by the tempered glass, which is placed by positioning the opening in the glass on the wooden construction. With the help of wooden wedges, the structure becomes stable despite the thin wooden elements.

Lovro Belina – *GlauWee*

“*GlauWee*” is a low table intended for cafés, living rooms, night clubs and waiting rooms. It is made of wood and glass, and is a combination of opposites – smooth/rough and warm/cold – which fit perfectly together. Various versions can include a low table with a drawer, with doors, and in a range of dimensions, depending on the desires of the customer. There is also the possibility of subtle storage of restaurant or entertainment items.



Igor Kolman – *Tree of life*

The inspiration for this table comes from the tree that gives wood, as one of the main elements for the design and construction of products. This gave the idea: the wood should give the “tree”, and so the “Tree of Life” was created as a harmonious blend of the profession, wood and nature.

Domagoj Mamić – *Dipole*

The low table is made of walnut. The elements are put together using magnets, allowing for rapid assembly and disassembly. The table functions when turned to either side, allowing the user to decide which side to use. The table top is toned transparent tempered glass. The multifunctionality of the product based on the side of use and the use of magnets as connective elements (pole as in magnetic pole) gave rise to the name “Dipole”. Magnets used in the table are an example of magnetic dipoles, which emphasises the further duality of use of the product.

Tomica Perković – *Criss cross*

The table is made of oak. The table is easy to assemble and disassembly as the central elements are connected in a cross shape. The tempered glass on the table surface has a mat finish and a thickness of 10 mm. In the central part of the table, the designer idea of wood penetrating through the centre of the glass is evident, thereby eliminating the monotony of form, and together with the glass creates an interesting combination of these two materials.

Ivan Ražov – *Deep*

The inspiration for this table was found at sea. The transparent, smooth, blue glass is reminiscent of the sea surface during calm weather, while the sea is calm, while the wood in the shape of a boat, and painted in a gradient, symbolises the increasing depth of the sea.

Valentino Slivar – *Lava Table*

The “Lava Table”, which with its contrast of bright red lava against the cold and rough surface of the glass creates a unique combination of visual elements, which will bring warmth into your home with light effects and their reflections on various surfaces. Though the lava motif is the first impression, the majority of the table consists of a rotating storage section, while its mild wooden texture calms and neutralises the dynamics of the glass surface. This table is ideal for those who love an innovative and impressive design that dominates the room and creates a pleasant, warm and modern solution suitable for everyday use.

Juraj Tomljanović – *L table*

Simplicity, luxury and uniqueness are the qualities that best describe the “L table”. The table legs are made of massive wood, topped by top quality fused glass. The construction of the leg section makes the table unique but interesting, while the fused glass, as the most creative glass work, achieves a unique effect and gives a dash of luxury. Considering that the texture of wood is never the same between two products, and every piece of fused glass is produced separated, every table is truly unique.

Lana Jarža / Serious





Ivana Hideg / Kayla





Igor Kolman / Drvo života





Tomica Perković / Criss cross

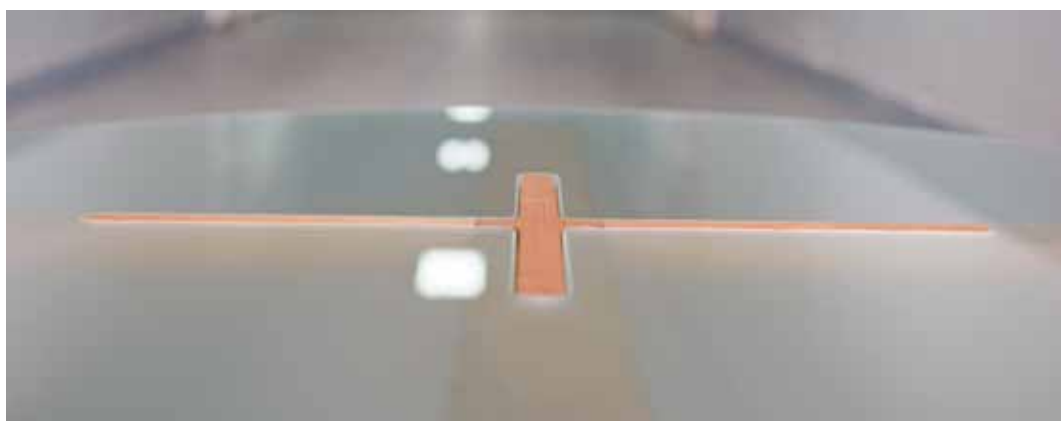



Valentino Slivar - Lava Table

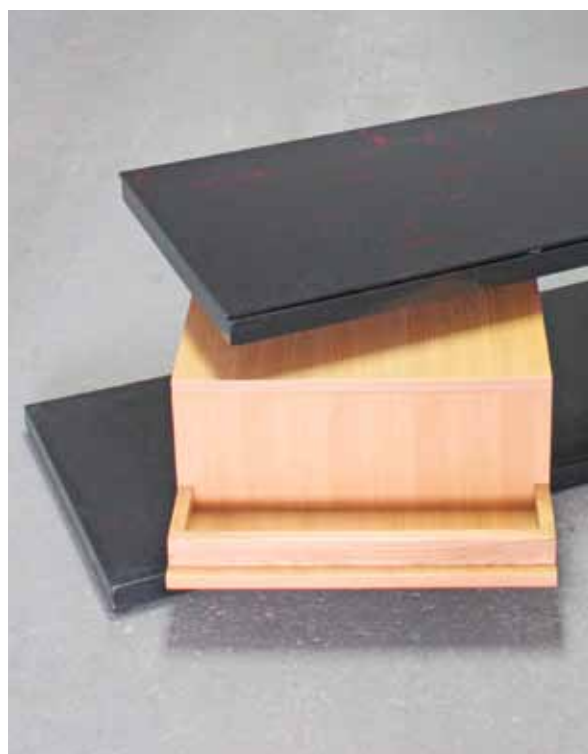
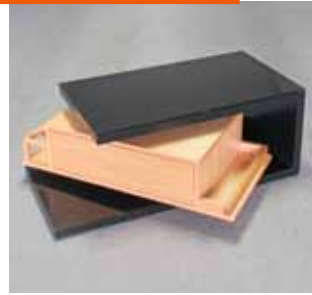

Juraj Tomljanović - L table



Međunarodni projekt CREAPOLIS

International project CREAPOLIS

Vrsta rada: Međunarodni projekt CREAPOLIS. Gradski muzeji i urbana kreativnost. Kulturne industrije u prošlosti i sadašnjosti (2016. - 2019.)

Autori: Lucija Marković, Petra Štajduhar, Gorana Vidić, Anđela Vuković, Margareta Kovačević

Mentor: Doc. dr. sc. Danijela Domljan

Naslov: Namještaj inspiriran tradicijom i baštinom RH

Projekt je zadatak proveden u suradnji s Etnografskim muzejom Zagreb radi sudjelovanja na izložbi i konferenciji europskoga projekta Creapolis održanoga u rujnu 2016. u Zagrebu u okviru kolegija Oblikovanje namještaja.

Cilj je projekta osmišljavanje inovativnih višefunkcionalnih elemenata namještaja u svakodnevnoj uporabi u stambenim prostorima koji odgovaraju suvremenim potrebama korisnika te koji primjenom dizajnerskih metoda u oblikovanju potiču kreativnost, svjesnost o hrvatskoj baštini i tradiciji te ekologiji i održivome razvoju.

Namještaj i oprema korištenjem tradicionalnih elemenata iz hrvatske povijesti i baštine imaju svrhu svojim izgledom i funkcijom poticati suvremeni način života, rad, kreativnost, zdravlje i dobrobit korisnika. Cilj je dizajnerskim pristupom i metodama (primjenom odgovarajućih boja, stila, materijala, konstrukcija i sl.) integrirati u suvremene proizvode kulturu, baštinu i tradiciju Republike Hrvatske. Sav namještaj treba biti osmišljen tako da poštuje dizajnerska, konstrukcijska, tehnološka, ekološka, ergonomska, ekonomska, izvedbena i ostala načela norme HRN EN, koja se odnose na kvalitetu namještaja te pravilnike, zakone, normative i važeće dokumente RH. Prilikom oblikovanja svih elemenata namještaja potiče se primjena drva i drvnih materijala porijeklom iz RH koja nose oznaku FSC, kako bi se pojačala svjesnost o primjeni zdrave i ekološki podobne domaće sirovine. Naglasak je na suvremenome načinu stanovanja i primjeni elemenata tradicije RH.

Type of work: International project CREAPOLIS. City museums and urban creativity. Cultural industries in past and present (2016 -2019)

Authors: Lucija Marković, Petra Stajduhar, Gorana Vidić, Anđela Vuković, Margareta Kovačević

Mentor: Danijela Domljan, PhD, Assistant Professor

Title: Furniture inspired by Croatian tradition and heritage

The project task was conducted in cooperation with the Ethnographic Museum in Zagreb, with the aim of participating in the exhibition and conference of the European project CREAPOLIS held in September 2016 in Zagreb.

The project aim was to design innovative multifunctional furniture elements for daily use in residential areas, which meet the contemporary needs of the user. Through the application of design methods in the design process, the goal was to encourage creativity, awareness of the Croatian heritage and tradition, and of ecology and sustainable development.

Using traditional elements of Croatian history and heritage, the furniture should encourage a contemporary way of living, working, creativity, health and well-being of the user. By using the design approach and methods (colours, styles, materials, construction, etc.) to integrate culture, heritage and tradition of the Republic of Croatia to contemporary products.

The furniture should be designed to respect the design, structure, technological, environmental, ergonomic, economic, performance and other principles of HR EN standards relating to the quality of furniture and regulations, laws, norms and valid documents of the Republic of Croatia. When designing the furniture elements, the use of wood and wood materials originating from the Republic of Croatia that carries the FSC symbol is encouraged, to raise awareness of the application of healthy and environmentally friendly domestic raw materials. The emphasis is on a modern lifestyle and the implementation of elements of the tradition of the Republic of Croatia.

Izložbe i konferencije

–

Exhibitions and conferences

Najbolja prepoznatljivost i izlaz iz anonimnosti postiže se sudjelovanjem na konferencijama i izložbama. Generacija studenata akademske godine 2015./2016. bila je jako vrijedna sudjelujući sa svojim radovima čak na 3 tuzemne i na jednoj inozemnoj izložbi. Prisutnost na tjednu dizajna mnoge je ugodno iznenadila, a mediji su vrlo pohvalno izdvojili proizvode naših studenata.

The greatest recognisability and way out of anonymity is achieved through participation at conferences and exhibitions. The generation of students in the 2015/2016 academic year were very busy, entering their projects into three domestic and one international exhibition. Their presence at Design Week pleasantly surprised many, and the media gave rave reviews of the works by our students.

Tjedan dizajna

Design week

Od 3. do 8. Svibnja 2016. u zgradi Hauba studenti Drvnotehnološkoga odsjeka Šumarskoga fakulteta izložili su svoje radove u obliku idejnih rješenja i proizvoda na 2 izložbena prostora. S ponosom možemo istaknuti da su ove godine studenti diplomskoga studija smjera Oblikovanje proizvoda od drva nadmašili sami sebe, barem prema kasnijim izjavama entuzijastične grupe Enable Table, koja u početku nije vjerovala da se može pokrenuti, dogovoriti, ubrzati, povezati i iznjedriti odličan projekt o kojemu će pisati i novine! Prema riječima Korane Sutlić, novinarka Jutarnjega lista, „...riječ je o prvoj generaciji studenata šumarstva koja je u dizajnerskom smislu izašla iz 'kutije'...”

(Sutlić, 2016.). Grupa Enable Table, kako se nazvala skupina od 10 studenata koju čine Lana Jarža, Domagoj Mamić, Lovro Belina, Igor Kolman, Tomica Perković, Ivana Hideg, Margareta Kovačević, Ivan Ražov, Juraj Tomljanović i Valentino Slivar, izložila je 10 stolova izrađenih u kombinaciji drva i stakla.

U sklopu suradnje s Drvnim klasterom Slavonski hrast javnosti su prikazana 2 prototipa – višefunkcionalnoga stola za Vijećnicu (Valentino Slivar, Lovro Belina, Ivan Ražov) te radnoga stola za računalnu učionicu, koji pripada projektu 202 (Valentin Slivar). Izložene prototipove izradila je stolarija Špurga d. o. o. iz Županje. Prototip konferencijskoga stola od bagremovine Lane Jarže, koji zbog velikih dimenzija nije bio izložen, izrađen je u suradnji s tvrtkom Kircek i Altravia, ali je bio predstavljen plakatom. Plakatom su predstavljeni i ostali radovi objedinjeni projektom Oblikovanje namještaja za opremanje obrazovnih institucija Republike Hrvatske: ŠKOLSKI RADNI STOL IZ HRASTOVINE (Lovro Belina, Ivana Hideg, Tin Lojen, Marta Badurina); PRENOSIVI ŠKOLSKI RADNI STOL (Ivan Lacković, Josip Svilić, Mihovil Karač); STOL ZA RAČUNALO S IZVLAČNOM POLICOM (Valentino Slivar); ŠKOLSKA KLUPA (Helena Borković, Franciska Klanfar, Melita Šomođi, Viktorija Jurina).

Uz navedene, studenti su izložili svoja idejna rješenja namještaja na posterima: Lupu – projekt kojim je Lana Jarža osvojila Rektorovu nagradu, mobilni kuhinjski ormarić Lucije Brglez, komodu Margarete Kovačević te poličar Ane Mišetić.





The students of the Wood Technology Section of the Faculty of Forestry took part in an exhibition at the Hauba design space from 3rd to 8th May 2016. They displayed their works in the form of design concepts and products in two exhibit spaces. We are proud that the students of the graduate study programme of Wood Product Design outdid themselves this year, at least according to the statements by enthusiasts of the group Enable Table, who could not believe that it was possible to launch, organise, accelerate, connect and execute an excellent project that even the press would write about! According to Korana Sutlić, a journalist for the daily paper Jutarnji List "...this is the first generation of forestry students to think outside the box when it comes to design..." (Sutlić, 2016). The Enable Table group, a group of 10 students (Lana Jarža, Domagoj Mamić, Lovro Belina, Igor Kolman, Tomica Perković, Ivana Hideg, Margareta Kovačević, Ivan Ražov, Juraj Tomljanović and Valentino Slivar), exhibited 10 tables made in a combination of wood and glass.

As part of the cooperation with the Slavonian Oak wood cluster, two prototypes were presented to the public, a multifunction table for a town hall (Valentino Slivar, Lovro Belina, Ivan Ražov) and a work table for a computer classroom, as part of the project 202 (Valentin Slivar). The exhibition prototypes were built by the carpentry company Špurga d.o.o. from Županja. The prototype of the conference table, made of acacia wood, by Lana Jarža, which was not exhibited due to its large size, was built in cooperation with the company Kircek and Altravia, and it was presented in the form of a poster. The poster also presented the other works, all brought together in the project of Designing furniture to equip educational institutions in the Republic of Croatia: SCHOOL WORK TABLE MADE FROM OAK (Lovro Belina, Ivana Hideg, Tin Lojen, Marta Badurina); MOBILE SCHOOL WORK TABLE (Ivan Lacković, Josip Svilić, Mihovil Karač); COMPUTER TABLE WITH PULL-OUT SHELF (Valentino Slivar); SCHOOL DESK (Helena Borković, Franciska Klanfar, Melita Šomođi, Viktorija Jurina). Additionally, students exhibited their concept designs for furniture on posters: Lupa – the project that brought Lana Jarža the Rector's Award, the mobile kitchen cabinet by Lucija Brglez, the cabinet by Margareta Kovačević and the bookshelf by Ana Mišetić.



Ambienta

Ambienta

Vrsta rada / događaja: Izložba projekata Razvoj novih proizvoda od slavonskoga hrasta i Enable table

Autori: Lovro Belina, Ivana Hideg, Igor Kolman, Ivan Ražov, Valentino Slivar, Juraj Tomljanović, Domagoj Mamić, Tomica Perković, Margareta Kovačević, Lana Jarža

Mentori radova: Izv. prof. dr. sc. Silvana Prekrat; Doc. dr. sc. Danijela Domljan

Naslov: Izložba projekata Razvoj novih proizvoda od slavonskoga hrasta i Enable table

Izložba studentskih radova u glavnome predvorju nove zgrade Šumarskoga fakulteta predstavlja dostignuća studenata na projektima Enable Table i Razvoj novih proizvoda od slavonskoga hrasta. Radovi su predstavljeni u okviru međunarodne drvnotehnoške konferencije, ICWST 2016 – Implementation of Wood Science in Woodworking Sector, koja se održavala 13. i 14. listopada 2016 godine u organizaciji Šumarskoga fakulteta. Izložba je obilježila i Dan fakulteta, Konferenciju HRVATSKI KVALIFIKACIJSKI OKVIR i brojne druge stručne i znanstvene događaje koji su se odvijali na fakultetu u razdoblju listopada do prosinca 2016. Izložbu je postavila doc. dr. sc. Danijela Domljan.

Vrijedno je spomenuti da je fotografija stola Tomice Perkovića – Criss cross poslužila za izradu naslovne stranice zbornika radova znanstvene konferencije.

Type of work: Exhibition of student works at the Faculty of Forestry

Authors: Lovro Belina, Ivana Hideg, Igor Kolman, Ivan Ražov, Valentino Slivar, Juraj Tomljanović, Domagoj Mamić, Tomica Perković, Margareta Kovačević, Lana Jarža

Mentors: Silvana Prekrat, PhD, Associate Professor; Danijela Domljan, PhD, Assistant Professor

Title: Exhibition of the projects Enable Table and Development of new products made of Slavonian oak

An exhibition of student works in the main hall of the new building at the Faculty of Forestry represents the achievements of students in the projects *Enable Table* and *Development of new products made of Slavonian oak*. The works were presented in the context of an international conference in woodworking, *ICWST 2016 - Implementation of Wood Science and Woodworking Sector*, which was held on 13th – 14th October 2016, organized by the Faculty of Forestry. The exhibition marked the Faculty Day, the conference CROATIAN CVALIFITAION FRAME and numerous other professional and scientific events that took place at the Faculty in the period October-December 2016. The exhibition concept was designed by Danijela Domljan, Assistant Professor.

It is worth mentioning that photos of the coffee table Criss Cross by student Tomica Perkovic - were used as the cover page of the Proceedings of the scientific conference.



Mjesec oblikovanja

Design month

Mjesec oblikovanja u Ljubljani jednomjesečna je manifestacija u sklopu koje se predstavljaju najbolji slovenski i strani produkt-dizajneri. Uz već nama dobro poznate hrvatske dizajnere na izložbi Znamke in znamenja, koja je trajala od 19. 10. do 19. 11. 2016. svojim prototipom stola „Serious“ izlagala je naša studentica Lana Jarža, koja je svojim idejnim rješenjem izmjenjivih ploča stola pobudila pohvale dizajnerskih kritičara.

The Month of Design in Ljubljana is a month-long event presenting the best of Slovenian and other product designers. The exhibit Znamke in znamenja was held from 19th October to 19th November 2016, and in addition to well known Croatian designers, student Lana Jarža presented the prototype of her table “Serious”. Her design concept for an interchangeable table top aroused praise from design critics.





ZNAMKE IN ZNAMENJA
BRANDS & SIGNS

**MIZA SERIOUS /
TABLE SERIOUS**

IDEJNOVANJE / DESIGN:
JARŽA LANA,
HRVAŠKA / CROATIA
IZDELAVA / PRODUCTION:
JARŽA LANA,
HRVAŠKA / CROATIA

MESE UJUNKOVANJA
LJUBLJANA 2016
MONTH OF DESIGN
LJUBLJANA 2016



A.L.I.C.E. – A.L.I.C.E.

Na konferenciji A.L.I.C.E., koja je održana 17. 11. 2016. pod naslovom Principles of sustainable storage furniture design studentica Lana Jarža izlaže rad koji će naknadno biti objavljen u zborniku pod naslovom Going Green Global – Sustainable design paradigms. Fotografije i vizualizacije proizvoda bili su izloženi u obliku postera u sklopu konferencije, a posteri su predstavljali rezultate suradnje na projektima s udrugom Slavonski hrast i tvrtkom Bokart. Plakati izloženi na konferenciji i njihova prezentacija pobudili su velik interes međunarodne javnosti i s različitim konceptima namještaja od hrastovine izvrsno su se uklopili u glavnu temu konferencije, koja se temelji na potrazi za konceptualnim stajalištima s obzirom na održivi razvoj odnosa između globalnoga gospodarstva i dizajna u najširem mogućem kontekstu.

At the A.L.I.C.E. conference, held on 17th November 2016 under the title “Principles of sustainable storage furniture”, a design student Lana Jarža exhibited her work that will also be published as part of the anthology entitled Going Green Global – Sustainable design paradigms. The photographs and visualisations of projects were exhibited in the form of posters during the conference, and the posters presented the results of cooperation on projects with the association Slavonian Oak and the company Bokart. Posters presented at the conference and their presentation aroused great interest of the international public, and the various concepts of oak furniture perfectly complemented the main theme of the conference, based on seeking out conceptual aspects concerning sustainable development of the relationship between the global economy and design, in the broadest possible context.



Terenska nastava

-

Field classes

Terenska nastava u Hrvatskoj

Field classes in Croatia

U sklopu redovne nastave i predmeta pod nazivom Terenska nastava studenti se nakon stečenoga teoretskog znanja upoznaju s praktičnim radom. S obzirom na širok djelokrug i multidisciplinarnost poslova povezanih s preradom, obradom drva i oblikovanjem proizvoda od drva terenska nastava obuhvaća različite vidove. U dogovoru s tvrtkama na početku svake akademske godine izrađuje se plan unutar kojega se posjećuju veći i manji drvoproizvođači kao što su pilane, proizvođači drvnih ploča, namještaja od cjelovitoga drva i ploča, ležaja i ojastućenoga namještaja, proizvođači i distributeri drvnoga materijala i okova za proizvodnju namještaja, proizvođači drvenih i montažnih kuća, drvenih podova te vrata i prozora. Osim navedenoga, studenti obilaze muzeje, i to posebno Etnografski i Muzej za umjetnost i obrt.

As part of regular classes and courses, once students have acquired the theoretical knowledge, they take part in the Field Class course to learn more about the practical aspects. Considering the broad scope and multidisciplinary nature associated with the processing of wood and design of wood products, the field course encompasses many different aspects. In agreement with companies, a plan is drafted at the start of each academic year, enabling students to visit large and small wood producers, such as sawmills, wooden panel producers, producers of furniture from massive wood and panels, beds and padded furniture, manufacturers and distributors of wood material and hardware for the production of furnishings, producers of wooden and prefabricated homes, wooden flooring, and doors and windows. Additionally, students visit museums, particularly the Ethnographic Museum and Museum of Arts and Crafts.



Terenska nastava u inozemstvu

Field classes abroad

Tradicionalno se svake godine organizira višednevna terenska nastava u inozemstvu, pri čemu se kombinira posjet stranomu fakultetu s odjelom drvne tehnologije, nekoj tvornici drvenih proizvoda, namještaja ili okova i instituta za ispitivanje namještaja. Gotovo redovito studenti organizirano posjećuju glavne sajmove na kojima dobivaju uvide o novim materijalima, poluproizvodima i tehnologijama.

Studenti Franciska Klanfar, Ivana Hideg, Helena Borković, Lovro Belina, Igor Kolman, Ivan Ražov, Valentino Slivar, Juraj Tomljanović iskustvo četverodnevne terenske nastave u Mađarskoj, Austriji i Njemačkoj opisali su ovako:

Od 16. do 19. 3. 2016. putovali smo na terensku nastavu u Mađarsku, Austriju i Njemačku fakultetskim autobusom s grupom od 44 studenata, asistenata i nastavnika Drvnotehnološkoga odsjeka Šumarskoga fakulteta. Tijekom putovanja posjetili smo Fakultet drvnih znanosti i muzej drva LIGNEUM, dva sajma i pet tvornica.

DAN 1 – 16. 3. 2016. Sopron, Mađarska

Dan smo proveli obilazeći tvornicu kuhinjskih pročelja IKEA Industry, muzej drva LIGNEUM i Fakultet drvnih znanosti. Smješteni smo bili u dva studentska doma u Sopronu.

DAN 2 – 17. 3. 2016. Unterradlberg, Ried im Innkreis, Mistelbach bei Wels, Austrija

Tvornice Egger, Silber Fenster i salon namještaja Team7 ogledni su primjeri dobro uređenih proizvodnih sustava, izvrsne organizacije rada i posebne brige o kupcu, što je na nas ostavilo velik dojam. Smješteni smo bili u hotelu u prekrasnome gradiću Rothenburg ob der Tauber.

DAN 3 – 18. 3. 2016. Tauberbischofsheim, Rothenburg ob der Tauber, Njemačka

U tvrtki WEINIG detaljno smo obišli pogon za proizvodnju strojeva za obradu drva i pratili detaljnu demonstraciju najmodernijih strojeva za piljenje, blanjanje, profiliranje i CNC obradu te proizvodnju alata za blanjanje. Ostatak dana proveli smo upoznavajući Rothenburg.

DAN 4 – 19. 3. 2016. Nürnberg, Njemačka

Na sajmovima smo prisustvovali demonstraciji niza inovativnih rješenja za strojeve za obradu drva, prozora i vrata te prateće tehnologije i materijala. Od izlagača smo dobili promotivne tiskane i videomaterijale te uzorke za nastavu. Nakon obilaska sajmova kratko smo upoznali Nürnberg, gdje smo osim turističkih znamenitosti vidjeli i niz mogućnosti uporabe drva kao građevnoga i dekorativnoga materijala. S puta smo se vratili u nedjelju ujutro.

Terenska nastava bila je izuzetno zanimljiva i ugodna te vrlo poučna i korisna te će nam ovo iskustvo zasigurno ostati u lijepome sjećanju.



Traditionally, every year a field trip abroad is organised. A visit to a foreign faculty with a section of wood technology is combined with a visit to a factory of wood products, furniture or shacks or institute for furniture research. Almost regularly students go on organised visits to main fairs where they can see new materials, semi-finished products and technologies.

Students Franciska Klanfar, Ivana Hideg, Helena Borković, Lovro Belina, Igor Kolman, Ivan Ražov, Valentino Slivar, Juraj Tomljanović described their 4-day-field classes in Hungary, Austria and Germany as follows:

From 16th – 19th March 2016, we took a field trip to Hungary, Austria and Germany with the faculty bus as a group of 44 students, assistant professors and teachers at the Wood Technology Section of the Faculty of Forestry. During our trip, we visited the Faculty of Wood Sciences and LIGNEUM wood museum, two fairs and five factories.

DAY 1 – 16th March 2016, Sopron, Hungary

We spent the day visiting the IKEA factory of kitchen fronts, the LIGNEUM wood museum and the Faculty of Wood Sciences, University of West Hungary. We were accommodated in two student residences in Sopron.

DAY 2 – 17th March 2016, Unterradlberg, Ried im Innkreis, Mistelbach bei Wels, Austria

The factories Egger, Silber Fenster and furniture showroom Team7 are good examples of quality arranged manufacturing systems, excellent work organization and special customer care that greatly impressed our group. We stayed at a hotel in the beautiful town of Rothenburg ob der Tauber.

DAY 3 – 18th March 2016, Tauberbischofsheim, Rothenburg ob der Tauber, Germany

At the company WEINIG, we received a detailed tour of the manufacturing machines for wood processing and we watched a demonstration of state of the art machines for sawing, milling, profiling, CNC processing and manufacturing tools for milling. We spent the rest of day exploring Rothenburg.

DAY 4 – 19th March 2016, Nürnberg, Germany

We visited fairs where we watched demonstrations of a number of innovative solutions of machines for wood processing, windows and doors, and supporting technology and materials. We received promotional printed and video materials and sample models for classes from the exhibitors. After visiting the fairs, we paid a short visit to Nürnberg, where we saw the possibilities of using wood as a construction and decorative material, in addition to taking in the sights. We returned from our trip on Sunday morning.

The field trip was exceptionally interesting, pleasant, very educational and useful. Surely, this experience will remain a lovely memory.

Mobilnost

-

Mobility

Mobilnost

Mobility

Jedan je od glavnih ciljeva Bolonjske deklaracije promicanje mobilnosti i prevladavanje zapreka slobodnomu kretanju te posebice studentima dati priliku za učenje na nekome drugom srodnom fakultetu. U ovoj su generaciji četiri studentice boravile u inozemstvu na izradi diplomskoga rada. U akademskoj godini 2015./2016. Erasmus+ studentsku mobilnost ostvarile su:

1. Karla Harazim

Faculty of Forestry and Wood Technology, Mendel University in Brno, Češka
Diplomski studij Oblikovanje proizvoda od drva, 2. godina, 2. semestar
Vrijeme boravka na razmjeni: 8. 2. 2016. – 8. 7. 2016.

2. Lucija Brglez

Faculty of Forestry and Wood Technology, Mendel University in Brno, Češka
Diplomski studij Oblikovanje proizvoda od drva, 2. godina, 2. semestar
Vrijeme boravka na razmjeni: 8. 2. 2016. – 8. 7. 2016.
Diplomski rad: Increase of wood based panels aesthetic properties as a result of wood chip staining
Diplomski rad: The impact of users' attitudes on health prevention in nursing homes

3. Ana Mišetić

University of Ljubljana, Biotechnical Faculty, Slovenija
Diplomski studij Oblikovanje proizvoda od drva, 2. godina, 2. semestar
Vrijeme boravka na razmjeni: 19. 2. 2016. – 9. 7. 2016.
Diplomski rad: Resistance of polyurethane varnish made of liquefied wood against artificial accelerated weathering

4. Margareta Kovačević

Faculty of Design, Trzin, Slovenija
Diplomski studij Oblikovanje proizvoda od drva, 2. godina, 2. semestar
Vrijeme boravka na razmjeni: 11. 2. 2016. – 30. 6. 2016.
Diplomski rad: Design of contemporary furniture based on tradition and heritage

Jedna od sudionica Erasmus+ razmjenu ocjenjuje sljedećim riječima:

Usudim se reći da je odlazak na strano sveučilište u sklopu programa Erasmus+, kao i sve što međunarodna razmjena nudi jednomu studentu u tome razdoblju, jednostavno neprocjenjivo i prekrasno iskustvo. Zahvaljujući upravo toj dobivenoj prilici i angažiranosti mentorice prof. Jirouš-Rajković imala sam sreću biti sudionikom razvoja novih znanstvenih saznanja, okusiti čari eksperimentalnoga rada te upoznati velike stručnjake i kolege s područja drvne tehnologije. Impresionirana sam bogatstvom iskustva, stečenim znanjem te nezaboravnim poznanstvima i prijateljstvima. Smatram da je program izvrsno osmišljen i preporučila bih ga svakomu studentu.

One of the primary objectives of the Bologna Declaration is the promotion of mobility and the surpassing of barriers to freedom of movement, particularly for students, giving the opportunity to study at a related institution. In this generation, four students spent time abroad in preparing their Bachelor's theses. In the 2015/2016 academic year, Erasmus+ student mobility was used by:

1. Karla Harazim

Faculty of Forestry and Wood Technology, Mendel University in Brno, Czech Republic

Graduate study of Wood Product Design, 2nd year, 2nd semester

Time spent on exchange: 8th February – 8th July 2016

Bachelor's thesis: The impact of resident attitudes on health prevention in homes for the elderly

2. Lucija Brglez

Faculty of Forestry and Wood Technology, Mendel University in Brno, Czech Republic

Graduate study of Wood Product Design, 2nd year, 2nd semester

Time spent on exchange: 8th February – 8th July 2016

Bachelor's thesis: Increase of wood based panels aesthetic properties as a result of wood chip staining

3. Ana Mišetić

University of Ljubljana, Biotechnical Faculty, Slovenia

Graduate study of Wood Product Design, 2nd year, 2nd semester

Time spent on exchange: 19th February – 9th July 2016

Bachelor's thesis: Resistance of polyurethane varnish made of liquefied wood against artificial accelerated weathering

4. Margareta Kovačević

Faculty of Design, Trzin, Slovenia

Graduate study of Wood Product Design, 2nd year, 2nd semester

Time spent on exchange: 11th February – 30th June 2016

Bachelor's thesis: Design of contemporary furniture based on tradition and heritage

One of the participants in the Erasmus+ exchange programme gave this description of the experience:

I would dare to say that going to a foreign university as part of the Erasmus+ programme, and all that the international exchange programme has to offer a student in that period, is simply an immeasurable and beautiful experience. Thanks to this opportunity and the dedication of my mentor Professor Jirouš-Rajković, I had the great fortune of being part of the development of new scientific findings, to experience the wonders of experimental work, and to meet great experts and colleagues in the field of wood technology. I am impressed with the wealth of experience, knowledge obtained and the unforgettable new friendships I have made. This programme is well conceived and I would recommend it to any student.

Naši budući studenti

–

Our future students

Naši budući studenti

Our future students

Rado ugošćujemo znatizeljnike kojima s veseljem pokazujemo vlastite rezultate ili želimo javnost senzibilizirati o važnosti i prednosti uporabe drva u proizvodima svakodnevne namjene. Posjećuju nas različite skupine laika i stručnjaka, no uvijek su nam posebno drage posjete srednjoškolaca, potencijalnih budućih studenata. Takva je bila i posjeta učenika 2. razreda Škole primjenjene umjetnosti i dizajna iz Zagreba u subotu 21. 11. 2015. Oni su posjetili Drvnotehnoški odsjek Šumarskoga fakulteta Sveučilišta u Zagrebu, a dovela ih je razrednica, gospođa Marina Ćurković, dipl. kem. ing., na čiji je poticaj posjet organiziran. U dogovorenome dvosatnom programu učenicima je predstavljen odabrani dio ispitivanja u Laboratoriju za fizikalna i mehanička svojstva drva, Laboratoriju za anatomska svojstva drva i zaštitu drva, Laboratoriju za drvo u graditeljstvu i Laboratoriju za ispitivanje namještaja i dijelova za namještaj.

Usto su učenici vidjeli kako izgleda i čemu služe Ksiloteka, Zbirka konstrukcijskih spojeva i sklopova te Zbirka pločastih materijala. Prema odazivu i reakcijama posjetitelja može se reći da su voditelji pojedinih dijelova programa ostvarili zanimljivo osmišljene predstave i predavanja. Zato vjerujemo da su gosti uz prikladne suvenire Šumarskoga fakulteta sa sobom ponijeli i želju da navrate opet.

We are always pleased to host those interested in what we do, and we take pride in displaying our results. We want to raise public awareness of the importance and advantages of using wood in daily use products. We regularly receive groups of laypersons and experts, but we are always pleased to receive secondary school students, as potential future students. On Saturday, 21st November 2015, we received the 2nd class of the School of Applied Arts and Design in Zagreb. They visited the Wood Technology Sector with their class teacher, Mrs Marina Ćurković, BSc, who organised this visit.

In the prearranged two-hour programme, pupils watched a demonstration of part of the testing we perform in the Laboratory for physical and mechanical properties of wood, the Laboratory for the anatomical properties of wood and wood protection, Laboratory for wood in construction, and Laboratory for testing furniture and parts for furniture.

Pupils also had the opportunity to see the Xylotheque and learn what it is used for, and view the Collection of construction joints, and Collection of panel materials. Based on their reactions, it appears that the lectures and demonstrations were interesting and well planned. Our guests took home some souvenirs from the Faculty of Forestry and we hope that they will come by again soon.



I oni su bili studenti
drvnotehnološkoga odsjeka

–

Once they have been students of
the wood technology department

Vinko Postić

Maroon Creations

Maroon Creations

Ah, ta današnja mladež! Bezobrazni su, samo gledaju u mobitel, psuju, slušaju groznu glazbu... Opaske su to koje se često i bez povoda „lijepe“ za naš podmladak, ali možda je bolje razmisliti prije nego što počnemo generalizirati; iznimaka uvijek ima, a mi ćemo vas upoznati s jednom. Stipan Bekavac i Vinko Postić jedni su od onih koji će vas odmah razuvjeriti. Pametni, sposobni, dečki s vizijom i ciljem koji čine brend Maroon Creations, a bave se izradom namještaja. Stipan je stručni prvostupnik ekonomije, s fokusom na brend menadžment i marketing, a Vinko diplomirani inženjer drvne tehnologije zadužen za dizajn i produkciju. U pomoć im ponekad dolazi i treći član, student grafičkoga dizajna Stjepan Postić, koji pomaže u cijelome procesu. Kako i kada ste uopće počeli izrađivati stvari, naše je prvo pitanje za ove kreativce. – Naša priča je počela još tijekom srednje škole izradom drvenoga stola za poker, kada smo shvatili da imamo određene afinitete prema produkt-dizajnu i izradi različitih konstrukcija od drveta, ali i drugih materijala. Budući da oboje razmišljamo izvan zadanih okvira i imamo velik broj ideja za različite vrste namještaja, početkom ove godine odlučili smo ujediniti snage i fokusirati se na realizaciju tih ideja.

Tako je nastao naš startup brend Maroon Creations – govore dečki i dodaju kako je ime nastalo spontano. – Samo ime Maroon Creations nastalo je na temelju vrste drveta kestena maruna i istoimene vrste tamnocrvene boje – kažu. Proces od ideje do realiziranoga proizvoda poprilično je složen, kreće od olovke i papira, a završava izradom zadanoga projekta uz svladavanje brojnih poteškoća s kojima se susreću. Ideje smišljaju radi stvaranja namještaja koji je ekološki prihvatljiv i koji se ističe svojim dizajnom. Samu ideju nakon skiciranja prenosimo u neki od softvera na računalu koji nam je dostupan te zadajemo početnu vizualizaciju prototipa. U početnoj nam je fazi važno da ideje budu jedinstvene i da se uklapaju u sliku brenda koju želimo stvoriti, stoga imamo velik broj skica i ideja od kojih ćemo samo dio realizirati.

Nakon odluke koji ćemo projekt realizirati započinjemo s nabavom materijala te definiranjem načina na koje ćemo izraditi pojedine detalje. U tome procesu često nailazimo na poteškoće s odabirom kvalitetnih dobavljača i s ograničenošću materijala koje hrvatsko tržište nudi za razliku od ostatka Europe. Inspirirani smo ljepotom drveta koje nam čini glavni materijal, važno nam je koristiti se kvalitetnim drvom poput jasena, hrasta i slično. Zatim slijedi ručna produkcija, pri kojoj veliku pozornost pridajemo detaljima i kvaliteti izrade. Važno je napomenuti da unatoč tomu što je riječ o ručnoj produkciji, imamo mogućnost zadovoljiti i veće narudžbe za uređenje različitih objekata – objašnjavaju Stipan i Vinko. Trenutačno imaju pet različitih drvenih modela u izradi, među kojima su podne i stolne lampe Hanging by a Thread i podne lampe Mirror spremne za prodaju.

– Realizaciju ideja započeli smo s izradom drvenih lampa s LED žaruljama zbog njihove štedljivosti i dugotrajnosti. Smatramo da drvene lampe uz samo osvjetljenje daju prirodnu toplinu interijeru, za razliku od uobičajenih željeznih i aluminijskih – kažu. I za kraj, pitamo simpatičan dvojac imaju li planova za budućnost. – Budući da smo mladi tim kolega, planovi za budućnost su nam poprilično ambiciozni. Trenutačno imamo određene projekte za izradu nekoliko novih modela lampa, ali i ostalih vrsta namještaja. Glavna su vizija i dugoročni cilj stvoriti serijsku proizvodnju namještaja u Hrvatskoj i okrenuti se prema izvozu proizvoda. Smatramo da u Hrvatskoj ima puno talenta i mladih poduzetnika s odličnim i originalnim idejama, ali su, nažalost, ograničeni zbog loše ekonomske situacije te slabe potpore nadležnih institucija. Stoga mi kao mladi poduzetnici, kako bismo ostvarili dugoročan uspjeh, moramo biti iznimno motivirani, sposobni adaptirati se te naučiti donositi pravovremene odluke za rješavanje različitih poteškoća u procesu. Sve to čini poduzetništvo zanimljivim i izazovnim – zaključuju Stipan i Vinko, a mi vas pozivamo da posjetite njihovu mrežnu stranicu ili Facebookov profil te im pišete.

Oh, today's youth! They are rude, always looking at their cell phones, swearing, listening to terrible music... These are but a few of the comments that often times without cause are "stuck" to our youth, though perhaps it is better to give it a good think before generalising. There are always exceptions, and we would like to introduce you to a couple. Stipan Bekavac and Vinko Postić are among those who are sure to immediately convince you. Smart, capable young men, with a vision and goal that makes up the brand Maroon Creations, a furniture company. Stipan is a professional bachelor of economics, with a focus on brand management and marketing, while Vinko is a wood technology engineer responsible for design and production. The third member, a graphic design student Stjepan Postić, jumps in occasionally when needed, to facilitate the entire process. "How and when did you start making things?" was my first question for these creative guys.

"Our story started during secondary school, when we built a wooden poker table. It was then that we realised we have a certain affinity for product design and building things out of wood, and other materials. Since we both like to think outside the box and we have a great number of ideas for different types of furniture, at the beginning of this year we decided to officially join forces and focus on making those ideas a reality. And that's how Maroon Creations came to be," they told me, adding that the name came spontaneously to them. "The name Maroon Creations comes from the type of tree, the maroon chestnut, and the dark reddish colour of the same name, maroon," they said. The process from the idea stage to the finished project is a complex one, from pen to paper, to building the item, overcoming numerous problems as the process unfolds. Their idea is to create furniture that is ecologically acceptable, while still standing out with good design.

"Once we've sketched our idea, we transfer it into computer software and begin the initial visualisation of the prototype. Initially, it was important for us that our ideas be unique and that they fit in to the image of the brand we wanted to build, and therefore, of the many sketches and ideas, only a few will actually come to fruition. Once we decide which projects to proceed with, we obtain the materials and define how to make certain details. In this phase, we often encounter difficulties with the selection of good suppliers and with the limitation of materials offered in the Croatian market, unlike the rest of Europe. We are inspired by the beauty of wood, which is our main material, and it is important that we use high quality woods, like ash, oak and similar. Then we begin manual production, paying a great deal of attention to details and quality. We should stress that even though these are hand produced, we still have the capability of filling larger orders to equip different buildings," explained Stipan and Vinko. They currently have five different wooden models in production, including the floor and table lamp Hanging by a Thread and the floor lamp Mirror that are ready for sale.

"We began actualising our ideas by building wooden lamps with LED bulbs, due to their long-lasting and efficient operation. We believe that wooden lamps, in addition to giving light, also give a natural warmth to the interior, unlike the usual iron or aluminium lamps," they say.

And finally, we asked this team about their plans for the future. "Since we are a young team, our plans are pretty ambitious. We currently have several projects to build new models of lamps, and other types of furniture. Our main vision and long-term goal is to create serial production of furniture in Croatia, and focus on export. We believe that there is a lot of talent and many young entrepreneurs in Croatia, with excellent, original ideas, but they are unfortunately limited by the poor economic situation, and weak support received by the institutions. Therefore we, as young entrepreneurs, have to be exceptionally motivated, capable of adapting, and know how to make timely decisions to resolve various difficulties in the process, if we want long-term success. All this makes this venture both interesting and challenging," concluded Stipan and Vinko. We invite you to take a look at their website or Facebook profile, and drop them a line.





Pero Martinić Jerčić

S Brodosplitom u bolji život

U splitskome sam škveru dobio mogućnost za ostvarenje ambicija povezanih s poslom, iskoristio sam ju i svojoj mladoj obitelji pružio bolji život.

Pero Martinić Jerčić, mladi magistar inženjer drvne tehnologije s otoka Brača, nakon što je diplomirao na Šumarskome fakultetu Sveučilišta u Zagrebu, smjer Proizvodni procesi, poslušao je savjet profesora Mladena Brezovića te se u listopadu 2013. godine putem e-pošte obratio Upravi Brodosplita s molbom za posao u struci.

Brodogradilište zapošljava velik broj ljudi raznih struka

Zbog složenosti građe brodogradnja povlači za sobom više industrijskih grana, tako da zapošljava i druge industrije među kojima su drvna i drvoprerađivačka.

BRODOSPLIT INTERIJER I ZAVRŠNI RADOVI d. o. o. i BRODOSPLIT NAMJEŠTAJ PO MJERI d. o. o. dva su poduzeća unutar BRODOSPLITA, koja organizacijskim sposobnostima, tehnološkom opremljenošću, kvalitetnim djelatnicima različitih struka i dugogodišnjom tradicijom mogu udovoljiti najzahtjevnijim projektima opremanja brodskih i vanbrodograđevnih interijera.

Kako se mladi Bračanin nakon diplome na Šumarskome fakultetu zaposlio u struci, iz Zagreba preselio u Split i postao škveranin, pročitajte u priči Pere Martinića Jerčića:

Strpljen – spašen

Poziv za sastanak u Brodosplitu sam primio krajem srpnja 2014. godine od Damira Ilaka, direktora tvrtke Brodosplit – Namještaj po mjeri. Tada sam radio kao stručni suradnik na Šumarskome fakultetu u Zagrebu, na EU projektu preuređenja Laboratorija za drvo u graditeljstvu. Kako me poziv zatekao u vrijeme dok sam bio na godišnjemu odmoru, odmah sam pristao i doputovao u Split.

Na sastanku u Brodosplitu direktor mi je pokazao radionicu i proveo me kroz škver. Nakon opsežna razgovora odlučio sam bez preduga razmišljanja – mijenjam radno mjesto, idem raditi u splitski škver. Prošao sam razgovor u ljudskim resursima, psihotestove i ostale potrebne stvari. Nakon potpisivanja ugovora s Brodosplitom, sa svojom sam mladom obitelji preselio u Split kako bih 1. listopada 2014. počeo raditi u brodogradilištu.

Postao sam škveranin

U posao me uveo poslovođa Ivica Đolonga. Budući da je brodogradnja kompleksan posao, morao sam puno učiti, i učim još uvijek, upoznajem se sa svim novostima s kojima se kao tvrtka dotičemo; usvojio sam suradnju s drugim strukama, novu terminologiju i tehnološke procese te svakim novim danom gradim novo iskustvo.

U 18. mjeseci rada 8 uspješno dovršenih projekata uz *Monet*, koji je pri kraju i *Flying Clipper* u očekivanju.

Prva novogradnja na koju sam ušao bila je 473 – *heavy lifter Jumbo Kinetic*. Paralelno se gradio i drugi brod za istoga naručitelja, novogradnja 474 – *heavy lifter Fairmaster*.

Polako i s puno strpljenja, poslovođa me pripremao za mjesto voditelja proizvodnje koje sam kasnije trebao zauzeti jer je gospodin Mirko Majce kroz godinu i pol dana trebao otići u mirovinu.

U to sam vrijeme vidio i prvo porinuće uživo. Bila je to novogradnja 475 – *River Cruiser*. Za to porinuće pripremali smo binu koju inače naša tvrtka radi za takve svečanosti.

S vremenom sam počeo samostalno voditi predaju stolarskoga dijela nadgrađa na novogradnji 473. Nakon toga, isti posao smo odradili i za novogradnju 474. Pritom smo uzeli i posao opremanja stambenih kontejnera, što je bio iznimno zanimljiv posao, jako sličan

opremanju kabina na brodu. Tada sam se prvi put susreo s procesom nabave, specifikacije i kontrole materijala. Počeo sam raditi i svoje prve prekovremene sate. Naučio sam sistem rada sa zidnim, stropnim i podnim oblogama koje i nisu toliko usko povezane za moju struku, ali sam brzo ušao u problematiku i usvojio potrebna znanja. Iskustvo sam širio na projektu postavljanja zidnih, stropnih i podnih obloga na velikim kontejnerima za naftna polja, koje je Brodosplit gradio za jednoga stranog naručitelja. Bio je to moj četvrti uspješno riješen projekt.

Sličan posao oblaganja kontejnera bio je i „mali, ali slatki” projekt oblaganja *Electric house* i *Diesel house* na dizalicama za tvrtku Kocks crane international. To smo praktički već mogli odraditi „zatvorenih očiju”.

U ljeto 2015. počeo je pravi izazov – opremanje luksuzne jahte, novogradnje 524, prve koju smo u škveru izgradili za našu Plovidbu. Prijašnji se izvođač nije proslavio te smo se morali u stisci s vremenom prihvatiti posla s podnim oblogama od tikovine. Tu sam već počeo raditi popodnevnu, pa i tri tjedna noćnu smjenu. Uspješno završen posao i odlazak jahte na sajam u Monaco učinio nas je iznimno ponosnima, na čemu nam je i predsjednik Uprave Brodosplita osobno čestitao.

Najveća i najluksuznija jahta u Hrvatskoj, prva novogradnja izgrađena za flotu BRODOSPLIT PLOVIDBE, elegantna mega jahta KATINA ušla je u uži izbor za prestižnu nagradu *The International Yacht & Aviation Awards 2016* u dvjema kategorijama: *Interior Design Power Yacht & Power Yacht over 60 m*.

U međuvremenu smo tjedan dana radili na slaganju štanda DIV grupe na sajmu ASDA u Spaladium Areni. Budući da je naša tvrtka preuzimala taj posao, trebalo je popisati materijal, fotografirati i pripremiti se za samostalno postavljanje štanda na drugim sajmovima.

Sljedeći projekt bio je novogradnja 482 – brod *Betonara* za tvrtku Plovput. Tada sam već usvojio pregled nacрта i specificiranje materijala za izradu traženoga namještaja. Paralelno s time, počeo sam izrađivati radne liste za radnike, slagati i potpisivati ugovore te zapisnike o gotovosti radova. S tim mi je uvelike pomogao i uputio me u novi dio posla gospodin Mirko Majce.

Trenutno radimo rekonstrukciju namještaja na novogradnji 732 – putničkoga broda *Monet*, također za našu Plovidbu. Rekonstrukciju je teže izvesti od opremanja potpuno novih prostora, ali ne sumnjam kako ćemo i taj posao uspješno dovesti do kraja.

S nestrpljenjem čekam naš dio posla na FLYING CLIPPERU, najvećemu jedrenjaku na svijetu, koji će moći ploviti na pogon vlastitih jedara.

„Drveće koje polako raste daje najbolje plodove.” ~ Helen Keller

Izvor:

<https://skveranka.wordpress.com/2016/07/22/s-brodosplitom-u-bolji-zivot/>

Pero Martinić Jerčić

A better life with Brodosplit

“I received the opportunity to achieve my professional ambitions at the Split shipyard – I grabbed the chance and made a better life for my young family.”

After graduating and receiving his Master’s degree in Wood Technology Engineering with a specialisation in production processes from the Faculty of Forestry, University of Zagreb, Pero Martinić Jerčić from the island of Brač, took the advice of his professor Mladen Brezović. In October 2013, he sent an e-mail to the management board of the shipyard Brodosplit introducing himself and asking for a job.

Shipyards employ large numbers of people of various professions

Due to the complexity of shipbuilding and the many industrial branches associated with it, shipyards also employ experts from other fields, including those from the wood and wood processing fields.

BRODOSPLIT INTERIJER I ZAVRŠNI RADOVI d.o.o. (Brodosplit Interiors and Finishing) and BRODOSPLIT NAMJEŠTAJ PO MJERI d.o.o. (Brodosplit Custom Furniture) are two companies within the BRODOSPLIT group. With their organisational capacities, technological equipment, high quality personnel from various professions, and a long tradition, they can satisfy even the most demanding projects to equip ships and other interiors.

Just how this young man from Brač, after receiving his degree at the Faculty of Forestry, received his first job in the profession, and how he moved from Zagreb to Split and became a shipyard worker, is outlined in the story of Pero Martinić Jerčić:

Patience is a saviour

I received the invitation for an interview at Brodosplit in late July 2014 from Damir Ilak, director at Brodosplit Custom Furniture. At that time, I was working as an expert associate at the Faculty of Forestry in Zagreb, on the EU project to refurbish the Laboratory for wood in construction. Since the invitation was received while I was on vacation, I immediately accepted and travelled to Split.

At the meeting at Brodosplit, the director took me on a tour of the workshop and the shipyard. After a long discussion, I decided without too much thought to take the job, and to become a Split shipyard worker.

I had interviews with the human resources department, filled out psychological evaluations and did all the other necessary steps. After signing the contract with Brodosplit, my young family and I moved to Split, and on 1st October 2014, I started working at the shipyard.

I became a shipyard worker

I was introduced to the job by manager Ivica Đolonga. Since shipbuilding is a complex business, I had a lot to learn, and I am still learning, getting to know all the novelties that we as a company are involved with. I have learned how to cooperate with other professions, learned all the new terminology and technological processes, and with each day I am building new experiences.

In 18 months on the job, we have already successfully completed eight projects, including the *Monet*, which is about to be completed, and the *Flying Clipper* which we are anticipating.

The first new build I was involved with was 473 – *heavy lifter Jumbo Kinetic*. Parallely, we were building a second ship for the same client, the new build 474 – *heavy lifter Fairmaster*. Slowly and with a great deal of patience, the manager prepared me to take over the position of head of production, since the current head, Mirko Majce, was planning on retiring in the next year and a half.

During that time, I watched my first live ship launch. That was the new build 475 – *River Cruiser*. For the launch, we prepared a stage that our company normally sets up for such ceremonies.

Over time, I began to independently run the handover of the carpentry section for the new build 473. Later, we performed the same for the new build 474. Then we also took a job to equip residential containers, which was an exceptionally interesting job, very similar to equipping ship cabins. This was the first time I encountered the processes of procurement, specifications and control of materials. I began working my first overtime hours. I mastered the system of working with wall, ceiling and floor panels, which are not so closely tied to my profession, but I quickly learned all I needed to know. I expanded this experience on the project of installing wall, ceiling and floor panels on large containers for oil fields, constructed by Brodosplit for a foreign client. This was my fourth successful project.

A similar job to panel containers was a “small, but sweet” project to panel the *Electric house* and *Diesel house* on cranes for the company Kocks crane international. This is something we were practically able to do with our eyes shut.

In summer 2015, a real challenge began – equipping a luxury yacht, new build 524, the first built in our shipyard for our fleet. The prior contractor did not prove themselves, and so we had to accept the job and install teak flooring in a tight timeframe. Here I already started working the afternoon shift, and for three weeks, the night shift too. The successful completion of this job and the departure of the yacht for the fair in Monaco made us exceptionally proud, and we received the personal congratulations of the chairman of the Brodosplit Management Board.

The largest and most luxurious yacht in Croatia, the first new build constructed for the BRODOSPLIT PLOVIDBA fleet, the elegant mega yacht KATINA, was selected in the final round for the prestigious award *The International Yacht & Aviation Awards 2016* in two categories: *Interior Design Power Yacht* and *Power Yacht over 60 m*.

In the meantime, we spent a week setting up the stand of the DIV Group at the ASDA Fair in the Spaladium Arena. Since our company took over this job, we needed to add materials, photographs and to prepare for the independent installation of stands at other fairs.

A similar project was the new build 482 – the ship *Betonara* for the company Plovput. At that time, I had already mastered the review of layouts and specified materials for building the requested furnishings. Parallely, I began creating work lists for employees, drafting and signing contracts, and records on work completion. Mr. Mirko Majce was a great help, introducing me to the new aspects of the job. Currently, we are working on the reconstruction of the furniture for the new build 732 – the passenger ship *Monet*, also for our fleet. Reconstruction is more difficult to perform than equipping a completely new space, but I am confident that we will successfully complete this job.

I am impatiently awaiting our part of the work on the FLYING CLIPPER, the world’s largest sailing ship, which will be able to sail on the power of its own sails.

“The tree that grows slowly gives the best fruits,” ~ Helen Keller

Source:

<https://skveranka.wordpress.com/2016/07/22/s-brodosplitom-u-bolji-zivot/>





Kontakti / Contacts



Dekan Šumarskoga fakulteta / Dean, Faculty of Forestry

Prof. dr. sc. Vladimir Jambreković / Professor Vladimir Jambreković, PhD

+385 1 2352 479, e-mail: vjambrekovic@sumfak.hr

Prodekan Drvnotehnološkoga odsjeka / Vice Dean, Wood Technology Section

Doc. dr. sc. Ivica Župčić / Ivica Župčić, PhD, Assistant Professor

+385 1 2352 439, e-mail: izupcic@sumfak.hr

Prodekan za međunarodnu suradnju / Vice Dean, International Cooperation

Prof. dr. sc. Stjepan Pervan / Professor Stjepan Pervan, PhD

+385 1 2352 509, e-mail: spervan@sumfak.hr

Prodekan za znanstvenoistraživački rad / Vice Dean, Scientific Research

Doc. dr. sc. Stjepan Mikac / Stjepan Mikac, PhD, Assistant Professor

+385 1 2352576, e-mail: smikac@sumfak.hr

Voditelj prediplomskoga stručnog studija Drvna tehnologija / Head of the undergraduate professional study programme Wood Technology

Prof.dr. sc. Stjepan Risović / Professor Stjepan Risović, PhD

+385 1 2352 437, e-mail: sisovic@sumfak.hr

Voditelj prediplomskoga sveučilišnog studija Drvna tehnologija / Head of the undergraduate university study programme Wood Technology

Doc. dr. sc. Vjekoslav Živković / Vjekoslav Živković, PhD, Assistant Professor

+385 1 2352 537, e-mail: vzivkovic@sumfak.hr

Voditelj diplomskoga studija Drvnotehnološki procesi / Head of the graduate study programme Wood Technology Processes

Doc. dr. sc. Igor Đukić / Igor Đukić, PhD, Assistant Professor

+385 1 2352 534, e-mail: idukic@sumfak.hr

Voditeljica diplomskoga studija Oblikovanje proizvoda od drva / Head of the graduate study programme Wood Product Design

Izv. prof. dr. sc. Silvana Prekrat / Silvana Prekrat, PhD, Associate Professor

+385 1 2352 408, e-mail: sprekrat@sumfak.hr

GODIŠNIAK

2015. — 2016.

YEARBOOK

Drvnotehnološkoga odsjeka
Wood Technology Section

